

TCL

OWNER'S MANUAL PORTABLE AIR CONDITIONER

Please read this manual carefully before operating your appliance and retain it for future reference.



MODEL: TAC-08CPA/HC
TAC-10CPA/HC

INTRODUCTION

IMPORTANT SAFETY INSTRUCTIONS	
Basic Safety Precautions-----	01
Electrical Safety-----	03
PARTS AND FEATURES	
Key Parts and Components-----	05
Control Panel-----	06
HOW TO USE	
Remote Controller-----	09
Using the remote control-----	10
INSTALLATION INSTRUCTIONS	
Preparing For Installation-----	13
Emptying the Water Collection Tank-----	15
CARE AND CLEANING	
Cleaning-----	16
TROUBLESHOOTING	
Before Calling for Service-----	17

IMPORTANT SAFETY INSTRUCTIONS

READ ALL INSTRUCTIONS BEFORE USE

Your safety and the safety of others is very important.

We have provided many important safety messages in this manual and on your appliance. Always read and obey all safety messages.



This is the safety alert symbol.
This symbol alerts you to potential hazards that can hurt you and others.

All safety messages will follow the safety alert symbol and either the word "WARNING" or "CAUTION".

These words mean:



WARNING This symbol indicates the possibility of death or serious injury.



CAUTION This symbol indicates the possibility of injury or damage to property.

BASIC SAFETY PRECAUTIONS



WARNING To reduce the risk of fire, electric shock, or injury

to persons when using this appliance, follow basic precautions, including the following:

- Do not attempt to repair or replace any part of your air conditioner unless it is specifically recommended in this manual. All other services should be referred to a qualified technician.
- If the power cord becomes worn or damaged, the cord should only be replaced by a qualified service technician using genuine replacement parts.
- The air conditioner should be plugged into its own grounded circuit (15A, 60Hz, 115VAC).
- Do not plug other appliances into the same outlet; it can overload the circuit and cause a fire or electric shock.
- Do not remove the round grounding prong from the plug. It can result in the risk of electric shock.
- Young children should be supervised to ensure that they do not play with or climb on the air conditioner.
- Be sure all packaging materials are removed from the air conditioner before use.
- Do not disassemble or modify the air conditioner or the power cord. It can result in the risk of electric shock or fire.
- Do not place the power cord or air conditioner near a heater, radiator, or other heat source. It can result in the risk of electric shock or fire.
- Do not use this or any appliance near flammable gases or liquids or other combustibles, such as gasoline, benzene, thinner, etc. It can result in the risk of electric shock or fire.
- Make sure the power cord is plugged firmly and completely into the outlet. It can result in the risk of electric shock or fire.

IMPORTANT SAFETY INSTRUCTIONS

READ ALL INSTRUCTIONS BEFORE USE

- Do not start or stop operation by plugging in or unplugging the power cord. It can result in the risk of electric shock.
- If the air conditioner is making unusual sounds or is emitting smoke or an unusual odor, unplug it immediately.
- Do not use if the electrical socket is loose or damaged. It can result in the risk of electric shock or fire.
- Do not operate with wet hands or in a damp environment.
- Do not use this or any electrical appliance if you smell gas. It can result in the risk of fire or explosion.
- Turn off and unplug the air conditioner before cleaning to avoid the risk of electric shock.
- Do not clean the unit with water. Water can enter the unit and damage the insulation, creating a shock hazard. If water enters the unit, unplug it immediately and contact Customer Service. It can result in the risk of electric shock.
- Utilize two or more people to lift and install the unit.

BASIC SAFETY PRECAUTIONS



CAUTION To reduce the risk of fire, electric shock, or injury

to persons when using this appliance, follow basic precautions, including the following:

- To avoid possible cuts, avoid contacting the metal parts of the air conditioner when removing or re-installing the filter. It can result in the risk of personal injury.
- Do not block the air inlet or outlet of the air conditioner. Reduced air flow will result in poor performance and could damage the unit.
- Always grasp the plug when plugging in or unplugging the air conditioner. Never unplug by pulling on the cord. It can result in the risk of electrical shock and damage.
- Always turn off and unplug the air conditioner when it will not be used for extended period of time. This conserves energy and reduces the chance of accidents.
- Secure the wheels with wheel locks to prevent the air conditioner from rolling on smooth floors.
- Install the air conditioner on a sturdy, level floor capable of supporting up to 110 lbs (50 kg). Installation on a weak or unlevel floor can result in the risk of property damage and personal injury.
- Make sure the air conditioner is the correct size for the area you wish to cool.
- Close all doors and windows to the room for most efficient operation.
- To prevent damage to the surface finish, use only a soft cloth to clean the air conditioner. Do not use wax, thinner, or a strong detergent.

IMPORTANT SAFETY INSTRUCTIONS

READ ALL INSTRUCTIONS BEFORE USE

- Do not position the air conditioner so that pets or house plants are exposed to the direct air flow.
- This air conditioner is designed for normal household use.
- Do not drink the water from the drain pan. Dispose of it properly outdoors or down the drain.
- Do not operate air conditioner without the filter securely in place. Operation without the filter could damage the unit.
- Clean the filter every two weeks, or more often if needed.

ELECTRICAL SAFETY



WARNING

Electrical Shock Hazard

- Failure to follow these instructions can result in death, fire, or electrical shock.
- This unit must be properly grounded.
- Do not, under any circumstances, cut or remove the ground prong.
- If you do not have a properly grounded outlet, or if there is any doubt that the outlet is not properly grounded, a qualified electrician should check the outlet and circuit, and, if necessary, install a properly grounded outlet.
- This air conditioner must be plugged into a grounded 60 Hz, 115 VAC outlet protected by a 15 amp time delay fuse or circuit breaker.
- This air conditioner must be installed in accordance with national wiring codes.
- Do not use an extension cord.

IMPORTANT SAFETY INSTRUCTIONS

READ ALL INSTRUCTIONS BEFORE USE

ELECTRICAL SAFETY

INTEGRATED CIRCUIT BREAKER

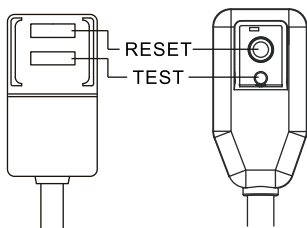

For additional safety, the power cord features an integrated circuit breaker. Test and reset buttons are provided on the plug case.

The circuit breaker should be tested periodically by pressing the TEST button. If it does not cause the circuit breaker to trip, or if the RESET button will not stay engaged, unplug the air conditioner immediately and contact your service technician.

Note: Your unit's power cord and plug may differ from above the picture shows.

PREFERRED GROUNDING METHOD

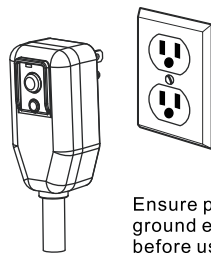

Ensure proper ground exists before use.

TEMPORARY GROUNDING METHOD

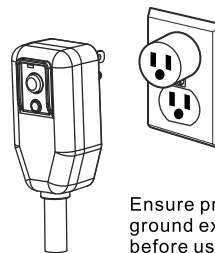

(Use of adapter plugs is not permitted in Canada)

Ensure proper ground exists before use.

Due to potential safety hazards, the use of an adapter plug is strongly discouraged.

To prevent damage to the adapter's ground terminal, hold the adapter in place while plugging in or unplugging the air conditioner.

Attaching the adapter ground terminal to the wall receptacle cover screw does not ground the appliance unless the cover screw is metal and not insulated, and the wall receptacle is grounded through the house wiring.

Frequent connection and disconnection can damage the ground terminal on the adapter. Never use a broken or damaged adapter.

SAVE THESE INSTRUCTIONS

PARTS AND FEATURES

KEY PARTS AND COMPONENTS

1. Air Outlet Grill
2. Control Panel
3. Carrying Handle
4. Casters/wheels
5. Power cord
6. Air Filter
7. Middle drainage
8. Air Exhaust
9. Air Intake Grill
10. Condensation Drain hole
11. Exhaust Hose
12. Window Kit Adapter
13. Exhaust hose connector
14. Window Kit
15. Caster Locks
16. Remote Controller
17. Rubber plug
18. Screws
19. Foam seal type 1
20. Foam seal type 2

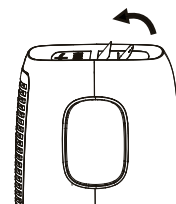
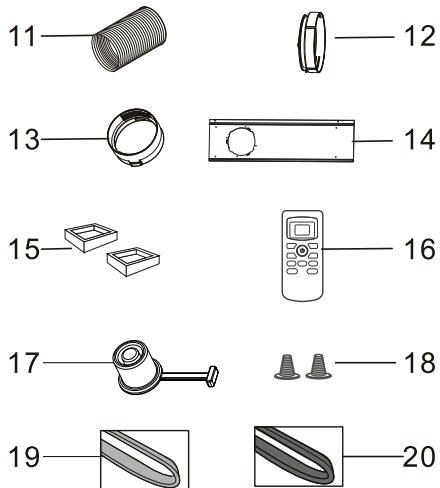
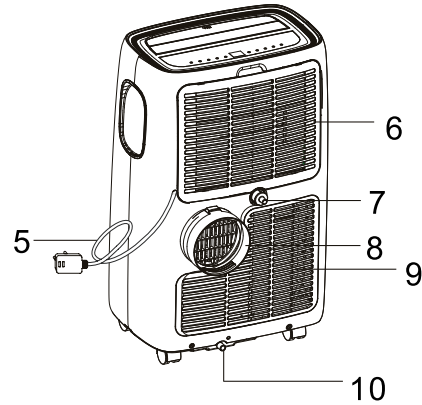
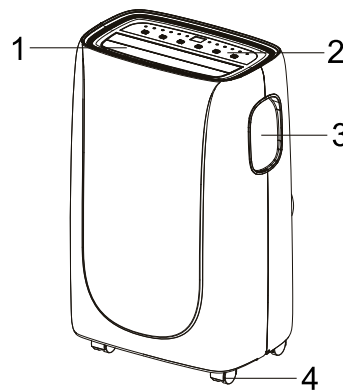

PARTS AND FEATURES

CONTROL PANEL

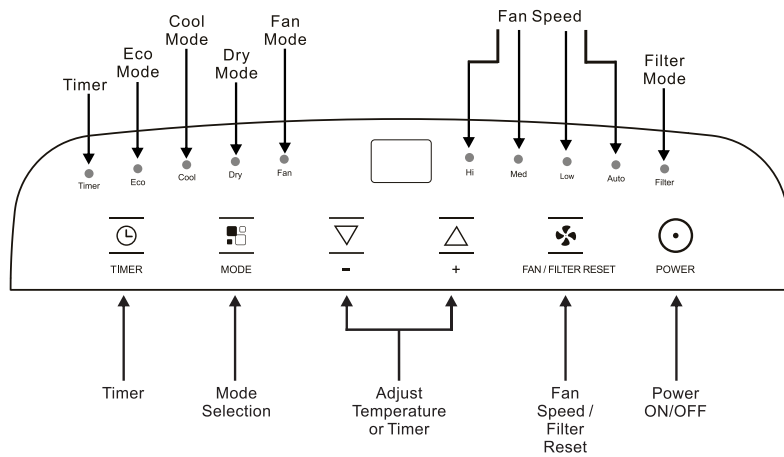

CONTROL PANEL

Power On and Off

Plug into the main socket. And the screen will display “ -- ”, like the picture below. Press the POWER button once to manually turn the unit on. Press the POWER button once more to turn the unit off.

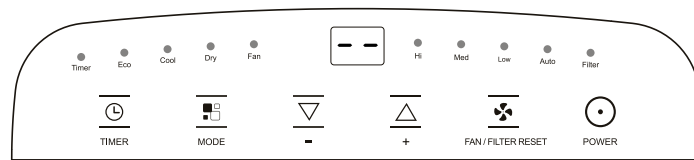

Cool mode

Press the POWER button to manually turn the unit on. Press the MODE button until the Cool mode indicator is light. Press the Fan speed button to choose the fan speed you want then the fan speed indicator will light. You can choose the “hi”, “med”, “low”, or “auto” fan speed setting. Press the “▼” and “▲” button to choose the temperature you want.

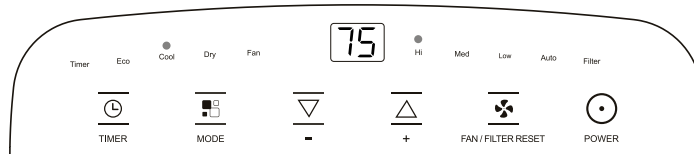

PARTS AND FEATURES

Dry mode

Press the "mode" button until the Dry mode indicator lights. The screen displays the room temperature. At the same time, the "low" fan indicator lights.

Note: In this mode, fan speed cannot be selected.

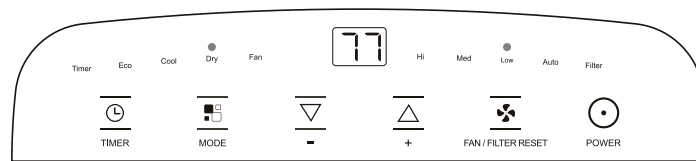

Fan mode

Press the "mode" button until the Fan mode indicator lights. In this mode, you can select fan speed "hi", "med", "low", or "auto". The screen displays room temperature.

Note: In this mode, the air exhaust hose does not need to be connected.

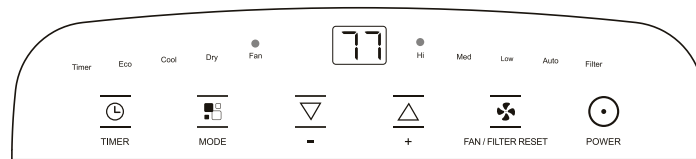

Eco mode

Press the "mode" button until the ECO mode indicator lights.

Press the "fan speed" button to choose the fan speed according to the illumination of the fan speed indicator.

You can choose the "hi", "med", "low", or "auto" fan speed setting.

Press the "▼" or "▲" button to choose the temperature you want.

In few seconds after you set the temperature, the screen will display the room temperature.

Note: The unit will run in energy saver(ECO) mode when used for the first time. In this mode, the fan will continue to run for 3 minute after the compressor shuts off. The fan then cycles on for 90 seconds at 10 minute intervals until the room temperature is above the set temperature, at which time the compressor turns back on.

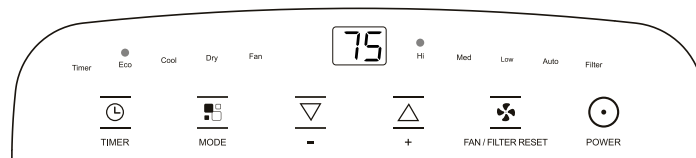

PARTS AND FEATURES

Timer mode

The timer facilitates the user to delay the unit startup or shutdown.

How to delay startup

Plug in the unit, so the unit turns to standby.

Press the "timer" button, then the Timer indicator and number of hours on the screen will flash.

Tap or hold the UP arrow (▲) or the DOWN arrow (▼) to change delay start timer at 0.5 hour increments up to 10 hours, then at 1 hour increments up to 24 hours.

After 5 seconds, the Timer indicator and the display stop flashing. The control will count down the time remaining until startup.

The unit will start up in the mode as previously set.

To cancel the setting, press the "timer" button again. The timer indicator will switch off.

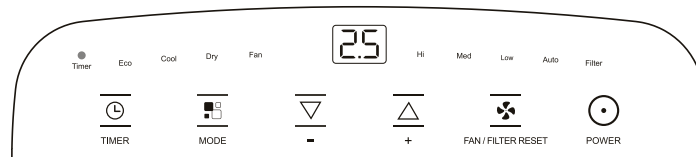

How to delay shutdown

You can delay shutdown when the unit is on.

Press the "timer" button, then the Timer indicator and number of hours on the screen will flash.

Tap or hold the UP arrow (▲) or the DOWN arrow (▼) to change delay stop timer at 0.5 hour increments up to 10 hours, then at 1 hour increments up to 24 hours.

After 5 seconds, the Timer indicator and the display stop flashing, and the display shows the time remaining until the unit shuts down.

To cancel the setting, press the "timer" button again. The timer indicator will switch off.

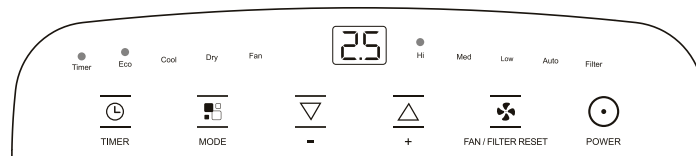

Filter reset

This feature is a reminder to clean the Air Filter (See Care and Cleaning) for more efficient operation.

The filter indicator will illuminate after 250 hours of operation. To reset after cleaning the filter, hold the "fan speed" button for 5 seconds, then the "filter" indicator will go off.

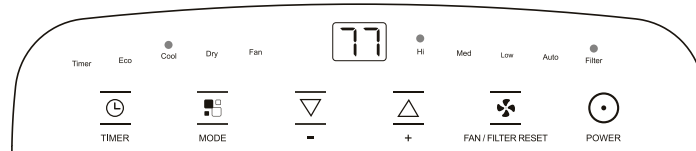

HOW TO USE

REMOTE CONTROL

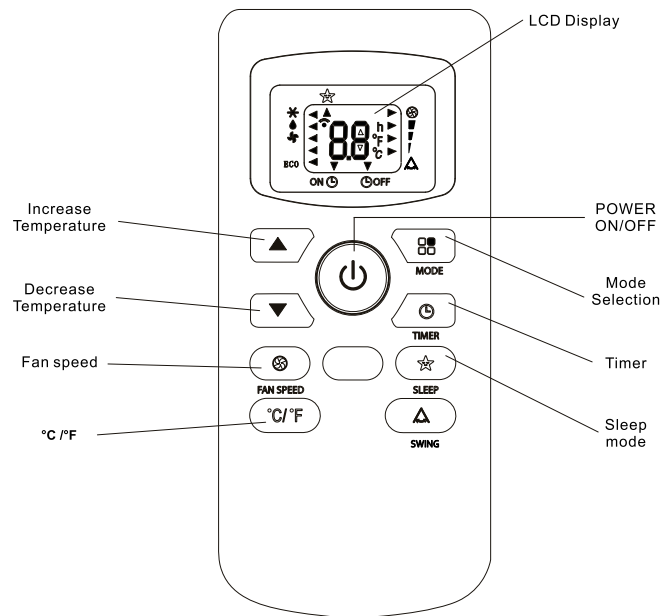

INSERTING OR REPLACING THE BATTERIES

Remove the cover on the rear of the remote control;
Replace the old batteries with two new "AAA" 1.5V batteries, inserting them correctly (see the instructions inside the battery compartment);
Replace the cover.

Point the remote control at the control panel on the unit. The remote control must be no more than 16 ft (5 meters) away from the unit (without obstacles between the remote control and the unit).

The remote control must be handled with extreme care. Do not drop it or expose it to direct sunlight or sources of heat.

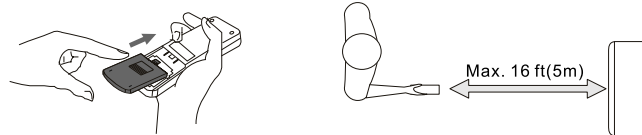

If the remote control unit is replaced or discarded, the batteries must be removed and disposed of in accordance with current legislation as they are harmful to the environment. Do not mix old and new batteries. Do not mix alkaline, standard (carbon-zinc) or rechargeable (nickel-cadmium) batteries. Do not dispose of batteries in fire. Batteries may explode or leak. If the remote control is not be used for a certain length of time, remove the batteries.

HOW TO USE

USING THE REMOTE CONTROL

TURNING THE UNIT ON

Plug into the outlet. Press the POWER button (when turned on, the unit starts operating in the same mode as when it was turned off).

To switch the unit off, press POWER button again, then remove the plug.

Do NOT switch the unit off by removing the plug.

Always switch it off by pushing on the POWER button and waiting few minutes before removing the plug. Only in this way the unit will perform the standard checkings.

Cool mode

Press the MODE button "☐" until the left side control LCD screen display an arrow "◀" light up next "❄". Press the Fan Speed button "⊗" to choose the fan speed you want then "▶" indicator will light.

You can choose the "Hi", "Med", "Low", and "Auto".

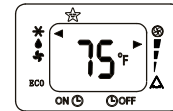

Press the "▼" and "▲" button to choose the temperature you want.

Dry mode

Press the MODE button "☐" until the arrow "◀" light up next "💧".

At the same time, the "▶" indicator is light next Low speed, other speeds cannot be selected.

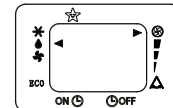

Fan mode

Press the MODE button "☐" until the arrow "◀" light up next "❄".

In this mode, you can selected fan speed "hi", "med", "low", or "auto" by press the Fan speed button.

In this mode the air exhaust hose does not need to be connected.

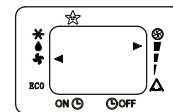

HOW TO USE

Eco mode

Press the MODE button " " until the arrow " ◀ " light up next " ECO ".

In this mode, you can selected fan speed "Hi", "Med", "Low" or "Auto" by press the Fan speed button.

Press the " ▼ " and " ▲ " button to choose the temperature you want.

Note: The unit will run in energy saver(ECO) mode when used for the first time. In this mode, the fan will continue to run for 3 minute after the compressor shuts off. The fan then cycles on for 90 seconds at 10 minute intervals until the room temperature is above the set temperature, at which time the compressor turns back on.

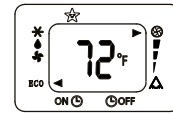

Sleep mode

When the unit is in Cool, Heat or ECO mode, you can press the "sleep" button to make the unit run in Sleep mode. In this mode, the fan speed will be set as "low" automatically, which cannot be changed.

In Cool or ECO mode the selected temperature will increase by 1 °F 60 minutes after the mode is selected. The temperature will then increase by another 1 °F after an additional 60 minutes. This new temperature will be maintained for 6 hours before it returns to the originally selected temperature. This ends the "Sleep" mode and the unit will continue to operate as originally programmed.

In Heat mode, the air conditioner will automatically decrease 1 °F per hour in a 3 hour period. The set temperature will be steady for the next 5 hours, then this mode will be terminated.

The "Sleep" mode program can be cancelled at any time during operation by pressing the "Sleep", "mode" or "fan speed" button.

Note: In Fan or Dry mode, Sleep mode cannot be set.

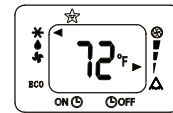

Louver Swing Function

Press the "swing" button to enable louver swing function, and the arrow " ▶ " light up next " ▲ ". The louver on the top panel will swing up and down.

Press this button again to disable the louver swing function.

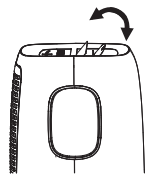
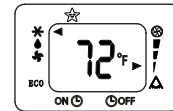

HOW TO USE

°F /°C function

Press the “°F /°C” button to switch between degree Fahrenheit and degrees Celsius.



Timer mode

How to program the delayed start up

Plug the unit into the outlet and turn the unit to standby. Press the Timer button “⏸”, the arrow “▼” flash above “ON⏸”. Now make all the desired settings for when the unit will switch on (operating mode, fan speed and temperature). Confirm the settings by pressing the timer button “⏸”. The time is displayed and the “h” symbol flashes.

Set the time when you want the unit to switch off using the buttons “▲” or “▼” (from 30 minutes to 24 hours). During the first ten hours, you can select half hour intervals. For times greater than ten hours, one hour intervals can be selected.

Press the Timer button “⏸” again to confirm the start-up time. A beep sounds a countdown of the time left on remote control display. At the end of the set time the unit start up automatically, with the settings made previously.

To cancel the timer programming, press the timer button “⏸” again. The unit emits a beep and display reset to stand-by.

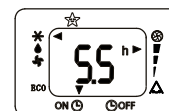

How to program the delayed shutdown

With the unit on, in every mode, it is possible to set the delayed shutdown.

Press the Timer button, the arrow “▼” will show above “OFF” indicator and “h” flash.

Press “▲” or “▼” to set the number of hours delay before the unit turns off.

Press Timer button again to conform the shutdown time. A beep sounds a countdown of the time left on remote control display.

At the end of the set time the unit shutdown automatically.

To cancel the timer programming, press the Timer button again. The timer indicator switches off.

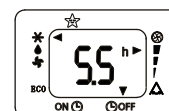

Fault Code

AS

If the screen on the unit displays “AS”, the room temperature sensor has failed. Contact your Authorize Service Center.

ES

If the screen on the unit displays “ES”, the pipe temperature sensor has failed. Contact your Authorize Service Center.

P1

If the screen on the unit displays “P1”, the water collection tank inside the unit should be full. Refer to the “Drainage Instructions” on Page 15 for more instructions to drain the successive condensate. If error repeats, contact your Authorize Service Center.

INSTALLATION INSTRUCTIONS

PREPARING FOR INSTALLATION

EXHAUSTING HOT AIR

In the Cool Mode the appliance must be placed close to a window or opening so that the warm exhaust air can be ducted outside.

First position unit on a flat floor and make sure there's a minimum of 12" clearance around the unit, and is within the vicinity of a single circuit outlet power source.

1. Extend either side of the hose (Fig.1) and screw the hose to connector A (Fig.2).
2. Extend the other side of the hose and screw it to connector B (Fig. 3).
3. Install the connector B into the unit (Fig.4).
4. Affix the connector A into the window slider kit and seal. (Fig.5&6)

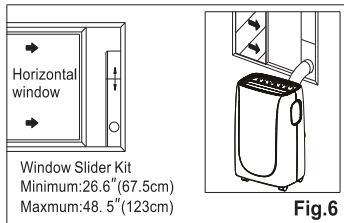
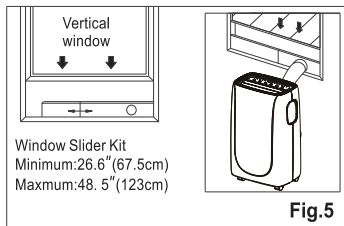

The hose can be extended from its original length of 15" up to 59", but it is best to keep the length to minimum required. Also make sure that the hose does not have any sharp bends or sags. (Fig.7)

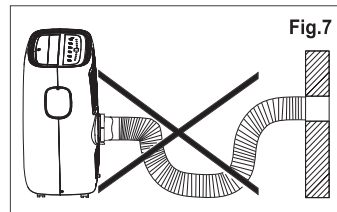
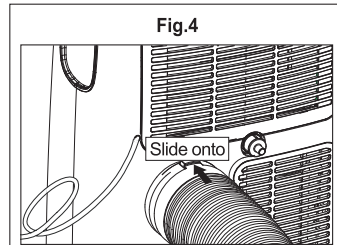
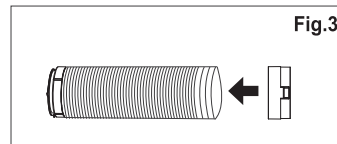
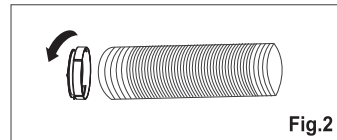
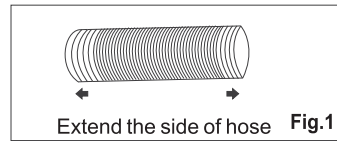

INSTALLATION INSTRUCTIONS

Installation in a double-hung sash window

1. Cut the foam seals A (adhesive type) to the proper lengths and attach them to the window and stool. (Fig. 8)
2. Open the window sash and place the window slider kit on the window stool (Fig. 9). Attach the window slider kit to the window stool. Adjust the length of the window slider kit according to the width of window. Screw down the two screws on the window slider kit. See Fig. 9. Cut the adjustable window slider kit if the width of window is less than 26.6 inches (Fig. 10).
3. Close the window sash securely against the window slider kit. (Fig. 11)
4. Drive two 1 / 2" screws to secure the window slider kit to the window sash. (Fig. 11)
5. Secure the window slider kit to the window stool (Fig. 11):
 - A: For wooden window: Use 3 / 4" screws for securing.
 - B: For Vinyl-Clad windows: Use 1 / 2" hex head cap screws for securing.
6. To secure lower sash in place, attach right angle sash lock with 1 / 2" (12.7mm) screw as shown (Fig. 12).
7. Cut the foam seal B to an appropriate length and seal the open gap between the top window sash and outer window sash, as shown in Fig. 13.

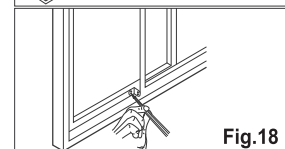
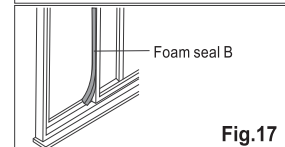
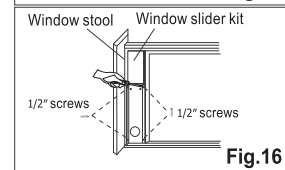
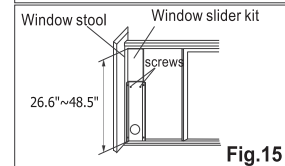
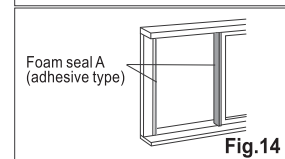
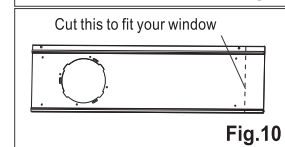
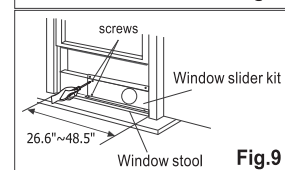
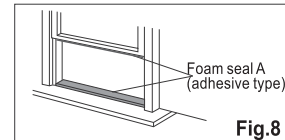
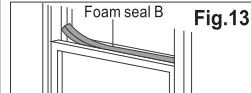
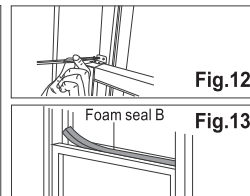
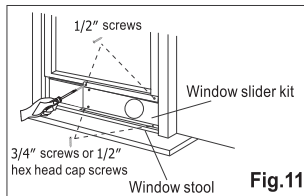

Installation in a sliding sash window

1. Cut the foam seals A (adhesive type) to the proper lengths and attach them to the window frame. See Fig. 14.
2. Open the window sash and place the window slider kit on the window stool (Fig. 15). Attach the window slider kit to the window stool. Adjust the length of the window slider kit according to the height of window. Screw down the two screws on the window slider kit. See Fig. 15. Cut the adjustable window slider kit if the height of window is less than 26.6 inches (Fig. 10).
3. Close the window sash securely against the window slider kit. (Fig. 16)
4. Drive two 1 / 2" screws to secure the window slider kit to the window sash. (Fig. 16)
5. Drive two 3 / 4" screws to secure the window slider kit to the window stool. (Fig. 16)
6. Cut the foam seal B to an appropriate length and seal the open gap between the sliding sash and outer window sash, as shown in Fig. 17.
7. To secure sliding sash in place, attach right angle sash lock with 1 / 2" (12.7mm) screw as shown (Fig. 18).

INSTALLATION INSTRUCTIONS

Continuous Drainage

During the DRY mode, you will need a garden hose (sold separately) to drain the condensate from the unit. Follow the steps below:

- Unscrew the drain cap of continuous drain outlet(Fig.20).
- Connect one end of the garden hose (sold separately) to the drain outlet then lead the other end into a drain that is lower than the unit(Fig.21).

Figure 20

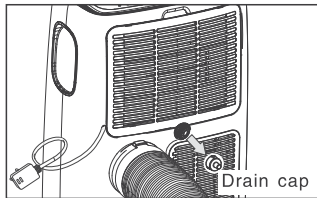
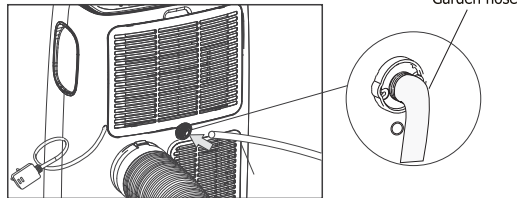

Figure 21



NOTE

- Condensate may flow out after removing the drain cap, if the unit is running in Cool or ECO mode. When you want to remove the garden hose, prepare a drip tray (not supplied) to collect the condensate from the drain outlet.
- Please be sure that the height of the drain and section of the drain hose should not be higher than that of the drain outlet, or the continuous drainage may not work properly.
- During Cool or ECO mode, it is recommended to disable continuous drainage by replacing the drain cap to the drain outlet, to reach the maximum performance.

Figure 22

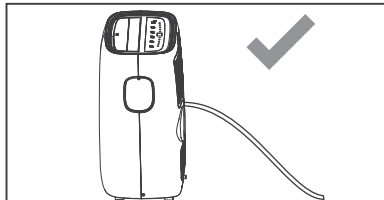
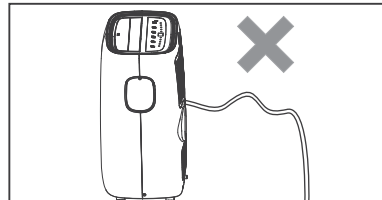

Figure 23



Emptying the condensate residue inside the unit during winter storage.

Put a drip tray (not supplied) under the continuous drain outlet, then unscrew the drain cap to allow the condensate to flow into the drip tray. Replace the drain cap to the continuous drain outlet when no condensate flows out.

Put the drip tray under the bottom drain outlet, then remove the rubber stopper from the drain outlet, to allow the condensate to flow into the drip tray. If your drip tray can't hold all the condensate, a number of fills will be needed.

Replace the drain cap to the bottom drain outlet when no condensate flows out.

Note: To ensure all condensate residue has been removed, tilt the unit by lifting it slightly upwards from the front until no more condensate comes out from the drain outlet.

Figure 19

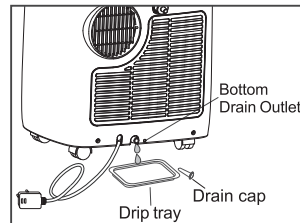

CARE AND CLEANING

Cleaning

Clean your air conditioner occasionally to keep it looking new. Be sure to unplug the unit before cleaning to prevent shock or fire hazards.

CLEANING THE UNIT

The cabinet and front may be dusted with an oil-free cloth or washed with a cloth dampened in a solution of warm water and mild liquid dishwashing detergent.

Never use harsh cleaners, wax or polish on the cabinet front. Be sure to wring excess water from the cloth before wiping around the controls. Excess water in or around the controls may cause damage to the air conditioner.

CLEANING THE FILTERS

To keep your air conditioner working efficiently, you should clean the filters every week of operation.

Grasp the upper panel tab and take off the filter which behind the grill of the back panel as shown the right fig.

Wash the filter using liquid dishwashing detergent and warm water. Rinse filter thoroughly. Gently shake excess water from the filter. Be sure filter is thoroughly dry before replacing.

Or, instead of washing you may vacuum the filter clean. Replace the filter after the filter is dry.

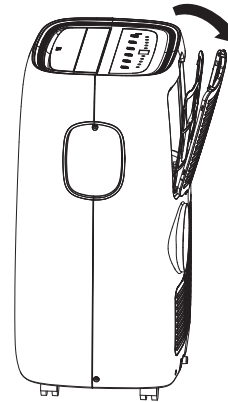

Winter Storage

If the air conditioner will not be used for an extended period of time:

1. Drain the water collection tank completely and leave the bottom drain cap and rubber plug long time enough to allow any residual water to drain out. Once the tank is completely drained and no more water flows out, reinstall the rubber plug and cap.

2. Remove and clean the filter, allow it to dry completely, then reinstall it.

3. Remove the batteries from the remote control.

4. Store the air conditioner in a cool, dry location, away from direct sunlight, extreme temperature, and excessive dust.

Before using the air conditioner again:

1. Make sure the filter and drain cap are in place.
2. Check the cord to make sure it is in good condition, without cracks or damage.
3. Place new batteries in the remote control.
4. Install the air conditioner as described in the Installation Instructions.

TROUBLESHOOTING

BEFORE CALLING FOR SERVICE

Before you call for service, review this list. It may save you time and expense.

Problem	Possible Causes	Solutions
Air conditioner will not start	<ul style="list-style-type: none"> The air conditioner plug is not completely inserted into the electrical outlet. The fuse is blown or the circuit breaker has tripped. Power failure. " P I " appears in the display. Room temperature is less than the set temperature. 	<ul style="list-style-type: none"> Make sure electrical plug is plugged completely into alive, properly grounded outlet. Replace the fuse or reset the circuit breaker. Make sure that there are no other appliances on the same circuit. If a power failure occurs, turn the power OFF. When power is restored, wait 3 minutes before restarting the air conditioner. The water collection tank is full. Drain the tank and reset your settings. See the Care and Cleaning section. This is normal. The air conditioner automatically shuts off when the room equals or is less than (Cool mode) or is more than (Heat mode) the set temperature. Adjust the temperature setting, if needed.
Air conditioner does not cool properly	<ul style="list-style-type: none"> Airflow is restricted. The air filter is dirty. The room is very hot, or not enough time allowed for cooling. Cold air is escaping. Cooling coils have iced up. 	<ul style="list-style-type: none"> Make sure there is sufficient clearance around the air conditioner and that the air inlet and outlet are not blocked. Clean the air filter at least every two weeks. See the Care and Cleaning section. When first turned on, allow the air conditioner sufficient time to cool the room. Check for open furnace, floor registers, cold air returns, open windows or doors. In especially cool, humid weather and when the air conditioner is running frequently or for extended periods, ice can form on the cooling coils, blocking air flow. It is normal, please adjust the temperature higher and High fan speed.
Air conditioner runs too often or too long	<ul style="list-style-type: none"> Area to be cooled is too large for the air conditioner. Doors or windows are open. 	<ul style="list-style-type: none"> Consult your dealer for the air conditioner capacity necessary to cool the desired area. Make sure doors and windows are closed.

