

# Installing the base stand (Instalación de la base de mesa)

Please put the TV face down on a safe surface and ensure the surface is flat and is able to support the TV, then install the base stand to the TV as follows:

Ponga el TV boca abajo sobre una superficie segura y asegúrese de que la superficie sea plana y de que pueda soportar el TV, entonces instale en el TV la base de apoyo de sobremesa de la manera siguiente:

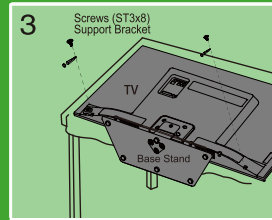
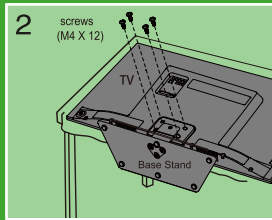
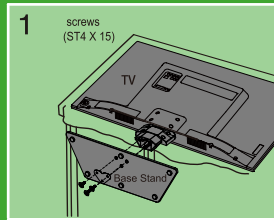

The step 3 is no need for models of 32"

### REMINDER:





Please keep the original carton box and packaging in order to protect the TV if moved or stored. Keep the screws and plastic parts away from grease and organic solvents to avoid damage. Especially during the assembly process. If you want to mount your TV to the wall, please purchase a VESA 100mm x 200mm and four screws M6x10. (four screws M4x12 only for 32")

### RECORDATORIO:

Conserve la caja de cartón y el material de embalaje originales para proteger el televisor al moverlo o almacenarlo. Evite que los tornillos y las partes de plástico entren en contacto con grasa y disolventes orgánicos para evitar daños. Especialmente durante el proceso de ensamblaje. Si desea montar su TV en la pared, compre un VESA de 100 mm x 200 mm y cuatro tornillos M6x10. (cuatro tornillos M4x12 sólo para los modelos de 32")

# Identifying cables (Identificación de los cables)

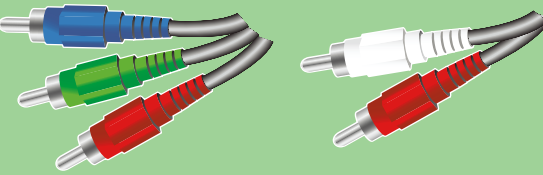
Your TV has several connection types for connecting devices. For the best video quality, connect a device to the best available connection. Su TV tiene varios tipos de conexión para diferentes dispositivos. Para la mejor calidad del video, conecte un dispositivo a la mejor conexión disponible.

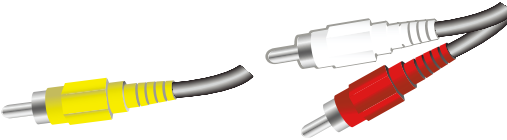
Connection type Tipo de conexión	Video quality Calidad del video	Cable connector Conector de cable
 HDMI video/audio Video/audio HDMI	Best La mejor	
OR		
 Component video and analog audio Video componente y audio analógico	Better Mejor	
OR		
 Composite video and analog audio Video compuesto y audio analógico	Good Buena	



The Creative Life

# QUICK SETUP GUIDE

Graphics contained within this publication are presentation only

### TTE Technology, Inc. Commercial Use Warranty

TTE Technology's Limited Warranty covers televisions sold to customers for non-commercial use for a period of one (1) year from the date of purchase, and for a period of six (6) months from the date of purchase for televisions sold for commercial use. Commercial use includes, but is not limited to, the use of this product in a commercial or business environment, the use of this product in an institution or for institutional purposes, or other commercial purposes including rental purposes. Please see the TTE Technology Limited Warranty for complete information.

### TTE Technology, Inc. Garantía para televisores vendidos para Uso Comercial

La Garantía Limitada de TTE Technology, Inc. A) Cubre por un período de un (1) año a partir de la fecha de la compra, los televisores vendidos a clientes para uso NO comercial, B) Y cubre por un período de seis (6) meses, a partir de la fecha de la compra, los televisores vendidos para uso comercial, El uso comercial incluye entre otros, su uso en un entorno comercial o de negocios, en una institución, o para propósitos institucionales, u otros propósitos comerciales, incluyendo los propósitos de alquiler. Consulte la Garantía Limitada de TTE Technology para una información completa.

# COLOR YOUR WORLD



Need assistance?

visit our website at [www.tclusa.com](http://www.tclusa.com)  
 or call 1-877-300-8837 (for mainland 48 States),  
 or 1-877-800-1269 (for AK, HI, and Puerto Rico).

# Connection & Setup

## Conexión y configuración

### 1 Antenna/cable connection

Conexión de la antena y el cable

Outdoor or Indoor Antenna  
Antena exterior o interior



or

HDMI connection as an alternative to cable input

La conexión HDMI es una alternativa a la entrada de cable

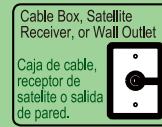

### 2 Power connection

Conexión de la alimentación

### 3 Turn on the TV

Encienda el TV



**Note:** Not all the cables are supplied with this unit. Please purchase the necessary cables.

**Nota:** No todos los cables se suministran con esta unidad. Compre los cables necesarios.

### 4 Initial Setup

Configuración inicial

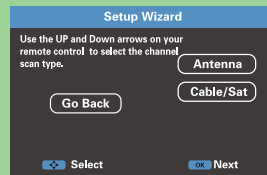
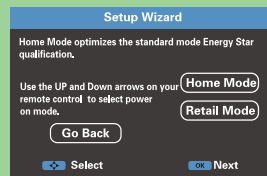

# External Component Connection (Conexión de componentes externos)

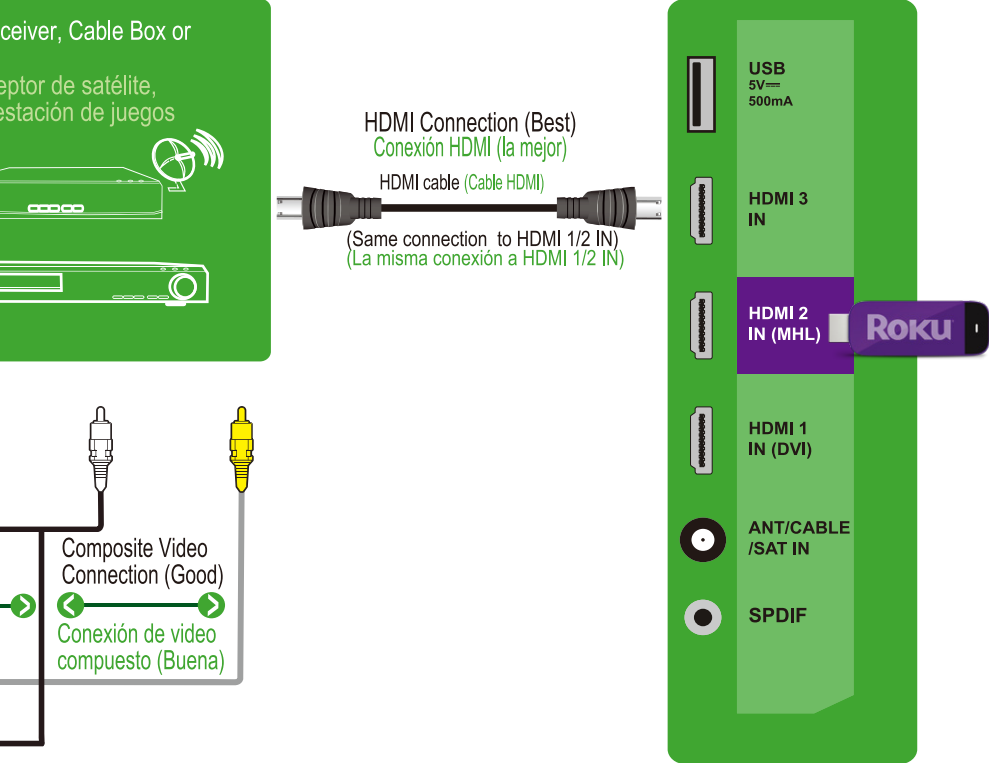
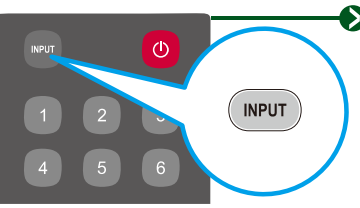
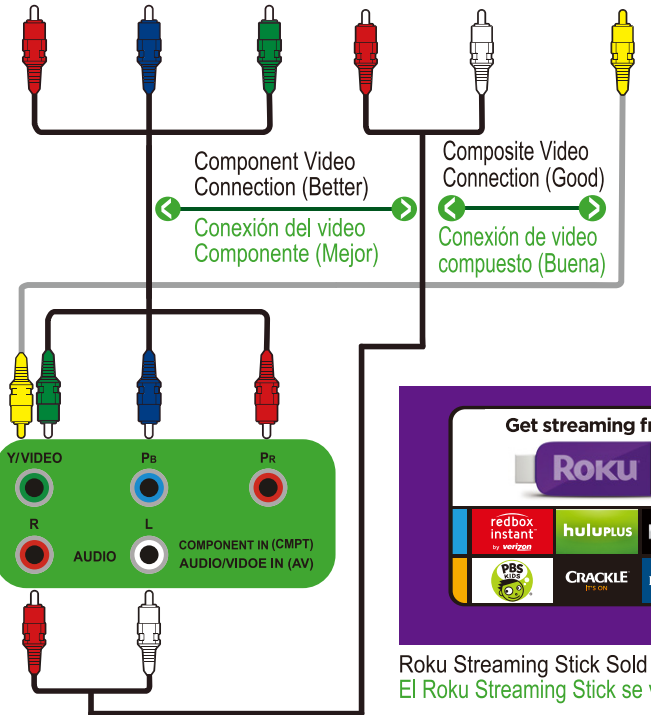

**Get streaming from:**

**One step to a smarter TV—Add the Roku Streaming Stick™**

- Enjoy more than 1000+ entertainment channels
- Stunning HD video quality, up to 1080p HD
- Extended-range, dual-band wireless
- No cables, MHL port powers streaming stick
- Control with Roku Ready® device remote and mobile app

Premium subscriptions not included with purchase.  
HBO GO® is only accessible in the US and certain US territories where a high-speed broadband connection is available. Some restrictions may apply. ©2013 Home Box Office, Inc. All rights reserved.

Roku Streaming Stick Sold Separately  
El Roku Streaming Stick se vende por separado

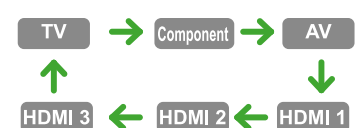

Only when plugging the Roku Streaming Stick into the MHL port of the TV, HDMI 2 is displayed as HDMI 2 (ROKU).

¿Necesita asistencia?  
Visite nuestro sitio Web en [www.tclusa.com](http://www.tclusa.com)  
o llame al 1-877-300-8837 (para los 48 estados dentro de Estados Unidos), o al 1-877-800-1269 (para AK, HI y Puerto Rico).