

TCL• Roku TV

User Guide

Models: 32S3850, 40FS3850, 50FS3850

Version 6.2

English

Illustrations in this guide are provided for reference only and may differ from actual product appearance. Product design and specification may be changed without notice.

Copyright

Portions © 2015 TCL and Roku, Inc. All rights reserved. ROKU, the ROKU Logo, and "NOW THIS IS TV." are trademarks and/or registered trademarks of Roku, Inc. in the United States and other countries. Material in this User Manual is the property of TCL and its subsidiaries, and Roku, Inc. and is protected under US and International copyright and/or other intellectual property laws. Reproduction or transmission of the materials, in whole or in part, in any manner, electronic, print, or otherwise, without the prior written consent of the TCL and Roku, Inc. is a violation of TCL and Roku, Inc.'s rights under the aforementioned laws.

No part of this publication may be stored, reproduced, transmitted or distributed, in whole or in part, in any manner, electronic or otherwise, whether or not for a charge or other or no consideration, without the prior written permission of Roku, Inc. and TCL.

Requests for permission to store, reproduce, transmit or distribute materials may be made to the following addresses:

TCL

Roku, Inc.

TCL, Roku, Inc. and any and all other TCL or Roku, Inc. product names, logos, slogans or marks are registered trademarks of TCL and its subsidiaries and Roku, Inc.. All other trademarks are the property of their respective holders.

Product name: TCL• Roku TV

Document name: TCL• Roku TV User Guide

Document revision: 6.2.1

Publication date: 12 May 2015

Important information

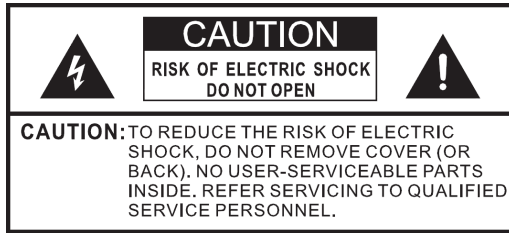

The lightning flash with arrowhead symbol, within an equilateral triangle is intended to alert the user to the presence of uninsulated dangerous voltage within the product's enclosure that may be of sufficient magnitude to constitute a risk of electric shock.



The exclamation point within an equilateral triangle is intended to alert the user to the presence of important operating and maintenance (servicing) instructions in the literature accompanying the product.



This symbol indicates that this product incorporates double insulation between hazardous main voltage and user accessible parts. When servicing, use only identical replacement parts.

WARNING: To reduce the risk of fire or electric shock, do not expose this product to rain or moisture. This product should not be exposed to dripping or splashing. No objects filled with liquids, such as vases, should be placed on or near the product.

WARNING: The TV is unstable if it is not properly attached to the base or mounted to the wall. Be sure to follow the base or wall mounting instructions provided in the User's Guide to ensure your safety.

WARNING: Do not expose batteries to excessive heat such as sunshine, fire, and so forth.

WARNING: This product contains chemicals known to the State of California to cause cancer and birth defects or other reproductive harm. For more information, go to www.p65warnings.ca.gov.

Proper operating voltage

Refer to the identification/rating label located on the back panel of your product for its proper operating voltage.

Cable TV installer notice of proper grounding

This reminder is provided to call your attention to Article 820-40 of the National Electrical Code (Section 54 of the Canadian Electrical Code, Part 1) which provides guidelines for proper grounding and, in particular, specifies that the cable ground should be connected to the grounding system of the building as close to the point of cable entry as practical.

Installation location

Important: This television is a table model and is designed to sit on a firm, flat surface. Don't place the TV on soft carpeting or similar surface because the ventilation slots on the bottom of the unit will be blocked, resulting in reduced lifetime from overheating. To assure adequate ventilation for this product, maintain a spacing of 4 inches from the top and side of the TV receiver and 2 inches from the rear of the TV receiver and other surfaces.

Also, make sure the stand or base you use is of adequate size and strength to prevent the TV from being accidentally tipped over, pushed off, or pulled off the stand. This could cause personal injury and/or damage to the TV. Refer to the Important Safety Instructions on the following pages.

Low power standby mode

The Power button (indicated by the power symbol) on this TV and its remote control puts the TV into a very low power standby mode but does not completely turn the power off. To completely shut the power off, you must disconnect the power cord from the power outlet. The mains plug/appliance coupler is used as a disconnect device. Therefore, you should be sure that the TV is installed in a manner to enable the power cord to be disconnected when necessary.

Note: In situations where the power plug or appliance coupler is used as the disconnect device, the disconnect device shall remain readily accessible and operable.

Important safety instructions

1. **Read instructions.** Read all the safety and operating instructions before operating the product.
2. **Retain instructions.** Retain the safety and operating instructions for future reference.
3. **Heed warnings.** Adhere to all warnings on the product and in the operating instructions.
4. **Follow instructions.** Follow all operating and use instructions.
5. **Water and moisture.** Do not use this product near water.
6. **Cleaning.** Clean only with a dry cloth.
7. **Ventilation.** Do not block any ventilation openings. Install in accordance with the manufacturer's instructions.
8. **Heat.** Do not install near any heat sources such as radiators, heat registers, stoves, or other apparatus (including amplifiers) that produce heat.
9. **Grounding or polarization.** Do not defeat the safety purpose of the polarized or grounding-type plug. A polarized plug has two blades with one wider than the other. A grounding type plug has two blades and a third grounding prong. The wide blade or the third prong are provided for your safety. If the provided plug does not fit into your outlet, consult an electrician for replacement of the obsolete outlet.
10. **Power cord protection.** Protect the power cord from being walked on or pinched particularly at plugs, convenience receptacles, and the point where it exits from the product.
11. **Accessories.** Use only attachments/accessories specified by the manufacturer.
12. **Stand/cart.** Use only with the cart, stand, tripod, bracket, or table specified by the manufacturer, or sold with the apparatus. When a cart is used, use caution when moving the cart/apparatus combination to avoid injury from tip-over.
13. **Power.** Unplug this apparatus during lightning storms or when unused for long periods of time.
14. **Servicing.** Refer all servicing to qualified service personnel. Servicing is required when the apparatus has been damaged in any way, such as power-supply cord or plug damaged, liquid has been spilled or objects have fallen into the apparatus, the apparatus has been exposed to rain or moisture, does not operate normally, or has been dropped.
15. If an outside antenna or cable system is connected to the product, be sure the antenna or cable system is grounded so as to provide some protection against voltage surges and built-up static charges. Section 810 of the National Electrical Code, ANSI/NFPA No. 70-2011 (Section 54 of Canadian Electrical Code, Part 1) provides information with respect to proper grounding of the mast and supporting structure, grounding of the lead-in wire to an antenna-discharge unit, size of grounding conductors, location of antenna-discharge unit, connection to grounding electrodes, and requirements for the grounding electrode. See following example:

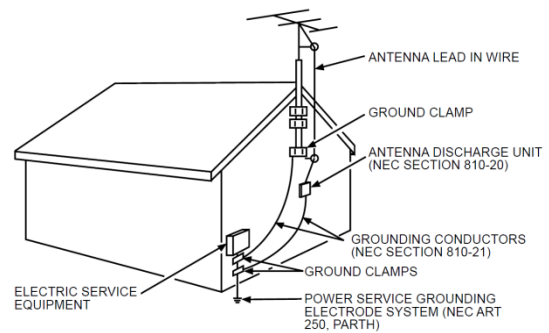

Contents

TCL• Roku TV.....	i
Important information	i
Important safety instructions.....	ii
Welcome	1
The new standard in Smart TVs.....	1
Get the most out of your new TCL• Roku TV	1
Connections and setup.....	3
Before initial setup	3
Set up your TCL• Roku TV	4
Connect your TCL• Roku TV	7
AC power	10
Remote control batteries	11
Guided Setup.....	12
Connected TCL• Roku TV Home screen	20
Non-connected TCL• Roku TV Home screen	22
Benefits of connecting	23
Connecting brings out your TCL• Roku TV's full potential!	23
What is streaming?.....	23
But what if I didn't connect my TCL• Roku TV?.....	24
Setting up Antenna TV	26
Why do I have to set up the TV tuner?.....	26
How do I set up the TV tuner?.....	26
Using your TCL• Roku TV.....	30
TCL• Roku TV status light	30
TCL• Roku TV panel buttons.....	30
Standby mode energy savings.....	31
Roku TV Remote control	31
Getting around	32
Watching broadcast TV channels	34
Switching TV inputs	36
Playing content from USB storage devices.....	36

Playing content from local network media servers.....	37
Adjusting TCL• Roku TV settings	38
Settings menu.....	38
Options menu.....	39
Advanced picture settings	40
The Roku Feed.....	43
Searching for movies & shows	44
How do I search?	44
I found a show, now what?	45
Using the Roku Channel Store.....	46
Customizing your TCL• Roku TV	47
Rearrange tiles	47
Edit broadcast TV channel lineup	48
Rename inputs	48
Remove unwanted tiles.....	49
Change themes.....	49
Change sound effects volume	50
Configure power settings	50
Configure parental controls	51
More settings	58
Changing network settings.....	58
Changing caption settings	59
Changing time settings.....	60
Scanning for broadcast TV channels again	61
Using the TCL• Roku TV in a home theater	61
Restarting the TCL• Roku TV	65
Resetting the TCL• Roku TV.....	65
Getting system updates	67
Other devices	69
Screen Mirroring your phone or tablet	69
Getting and using the Roku mobile app	69
Using a universal remote.....	69
FAQ.....	70
Other information	71
Battery Caution and Disposal Information	71
Electronics Recycling	71

Care and Cleaning..... 71
Television Specifications..... 72
Notices..... 72
Additional TCL Legal Statements 80

Welcome

Congratulations on the purchase of your new TCL • Roku TV! Discover the joy of endless entertainment. After it's set up, you'll be able to access a world of streaming content channels that may include Netflix, YouTube, Crackle, CNET and literally thousands more. Also, your TCL• Roku TV will receive automatic updates, enabling new content and features.

The new standard in Smart TVs

Welcome to TV like you've most likely never seen before—a home screen that you can personalize with your favorite devices and streaming channels. Choose from hundreds of thousands of streaming movies and TV episodes, plus music, sports, kids, family, international and much more. You should never run out of things to watch.

Note: *Some channels require payment and/or a subscription to access content. Channel availability is subject to change and not all content is available in countries or regions where Roku products are sold.*

Get the most out of your new TCL• Roku TV

Follow these simple steps to get the most out of your new Roku TV.

1. Connect to the Internet
 - It's simple, it's easy, and it will unlock a world of entertainment. All you need is a wireless network. There are hundreds of free streaming channels, subscriptions services like Netflix and Spotify, convenient ways to rent or buy a favorite film or show with Google Play and Cineplex and more.
2. Pick your favorite streaming channels
 - Find the entertainment you love. From the latest blockbuster movies to your favorite TV shows, with tons of live sports, a broad selection of music streaming channels, popular programming in a dozen international languages, 24x7 live news and so much more, your new Roku TV has your sweet spot. Some channels require payments.

3. Personalize your home screen
 - Put your favorite broadcast TV, streaming channels, gaming console and other devices front-and-center on the home screen. No more flipping through inputs or wading through complicated menus. You can even personalize the names of each input and move tiles around so your most-often used devices and streaming channels are only a click away.
4. Search for your favorite movie, TV show, actor, or director
 - Once you're connected to the internet, you can easily search across top streaming channels by movie or TV show title, actor or director—all from one place. Search results are organized by price so you can always see the best priced option. Some channels require payments.
5. Send your personal media to the big screen
 - Send personal photos, videos, and music from your smartphone or tablet to the TV screen in just a few taps. Plus, with Netflix and YouTube apps and any applicable subscription, send movies, shows, sport highlights, and more directly to your Roku TV.
6. Follow movies coming soon
 - Use My Feed to choose from and follow a list of upcoming movies, and then watch for alerts each time one of your followed movies becomes available or changes price.
7. Take charge with a smartphone or tablet
 - Control your Roku TV with the included remote or from your smartphone or a tablet with the free mobile app for iOS, Android, and Windows devices. Browse channels, view My Feed, and even search with voice via free mobile app.
 - Mirror your smartphone or tablet on your Roku TV. Share videos, photos, web pages, and more from compatible devices.

Note: *Many features work with top mobile devices. Go to support.roku.com for device compatibility information*

Let's get started.

Connections and setup

Before initial setup

Protect against power surges

- Connect all components before you plug any power cords into the wall outlet or power strip.
- NEVER plug your TCL Roku TV into an outlet that is controlled by a wall switch.
- Turn off the TV before you connect or disconnect any cables.
- Make sure all antennas and cables are properly grounded. Refer to the Important Safety Instructions.

Safety information

- Prevent TV from overheating by placing in an area with good ventilation.
- Do not block ventilation holes on the TV. Position the TV so air can circulate freely on all sides.
- Do not stack objects on the TV.
- If you place the TV on a stand, make sure you allow adequate ventilation.
- If you connect an audio receiver or amplifier to the TV, place it on the top shelf so the heated air will not overheat the TV.

Avoid audio interference

- Position cables properly; insert each cable firmly into the designated jack.
- Route all cables down one side of the back of the TV instead of straight down the middle.
- If your antenna uses 300-ohm twin lead cables, do not coil the cables.
- Keep twin lead cables away from audio/video cables.

Avoid direct light

Do not place the TV where sunlight or room lighting is directed toward the screen. Use soft or indirect lighting.

Set up your TCL• Roku TV

Open the box and remove the TV and other items. Be careful, the TV is heavy!

What's in the box



Roku TV



TV stand
base

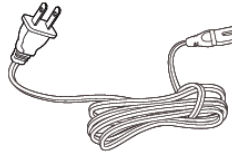

Power
cord

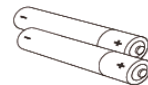

2 x AAA batteries
for remote

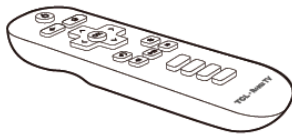

TV remote



4 Phillips screws
(ST4X25mm)

To mount on a wall

If you are mounting your TCL Roku TV to the wall, do not attach the TV base stand or TV stand column.

To mount your TV to the wall, purchase one of the following VESA wall mounts:

- **32" models** VESA 200 x 150, M4 x 12mm screws
- **40" models** VESA 100 x 150, M6 x 16mm screws
- **50" models** VESA 200 x 200, M6 x 16mm screws
- **55" models** VESA 200 x 200, M6 x 12mm screws

The VESA number is the horizontal and vertical measurement of the mounting holes. For example 100 x 200 indicates that the mounting holes are spaced 100mm horizontally and 200mm vertically.

Follow the directions supplied with the wall mount to mount the TV to the wall.

Caution: Your wall mount must be able to bear a minimum of five times the TV's net weight to avoid damage.

To use the stand

Your TCL Roku TV comes without the stands attached so that you can choose to use the stands or mount your TV to a wall using a wall mount (sold separately). If you want to mount your TV to the wall, don't attach the stand legs.

A – Place the TV face down on a soft, cushioned surface on a table. The bag the TV was packed in makes a good cushion. Position the TV so that the stand, when attached, will hang over the edge of the table.

B – Align the stands with the screw holes located on the TV stand column:

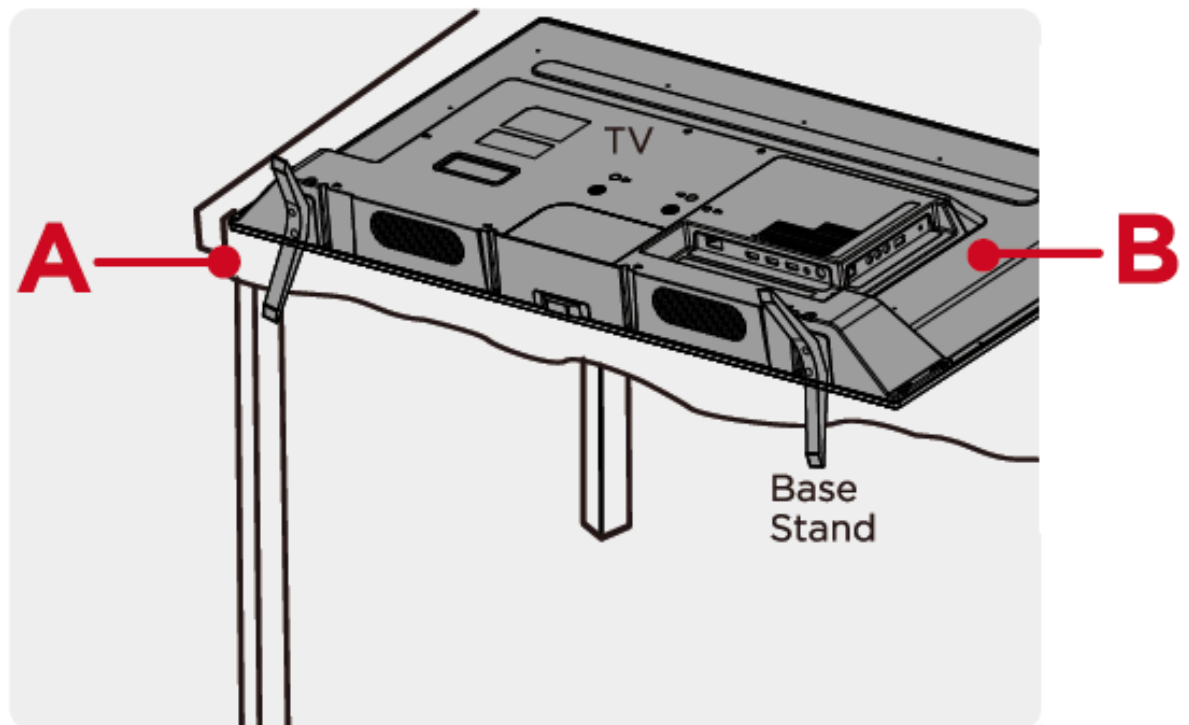

C – Secure stands to the TV with the four (4) screws..

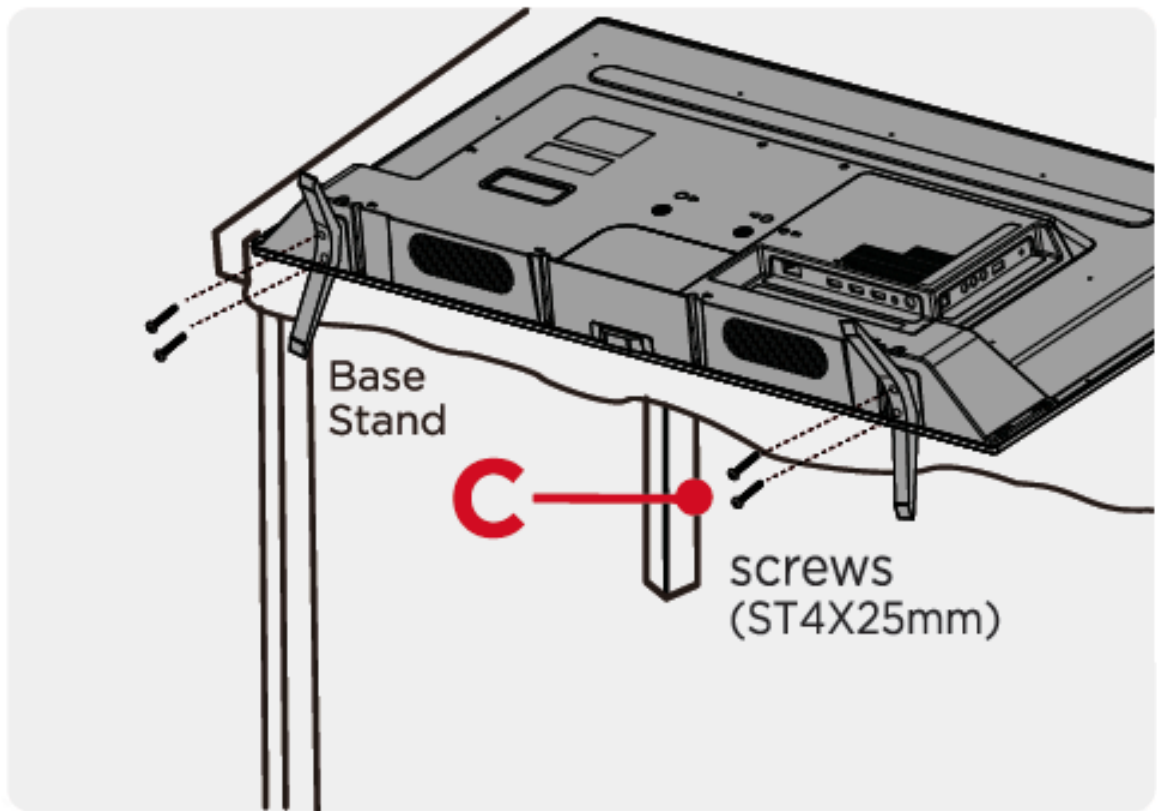

Connect your TCL• Roku TV

This section explains how to connect your devices to your TV.

Connecting an antenna, cable, or satellite box

If you are using an antenna, CATV cable without a set-top box, or a cable or satellite box that has only an antenna output, connect a 75-ohm coaxial cable (not provided) from the device to the ANT/CABLE input on the TV.

Tip: If you are using an antenna with a 300 ohm twin-lead cable, you need to use a 300-75 ohm adapter (not provided) to adapt the cable to a connection that is compatible with the TV's antenna input.

Tip: If you receive your TV stations through a set top box from a cable or satellite TV provider, connect it to the TV using the best connection method available. From most to least desirable:

- **HDMI® input** – Digital HD and SD video
- **AV input** – analog SD video
- **Antenna input** – analog SD video using NTSC

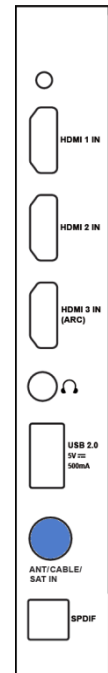

Connecting a component with a composite AV video cable

If the best connection available on your component is AV or composite video output, connect it to the TV using a composite AV cable (not provided). Composite AV cables typically have three RCA-type plugs on each end, color coded as follows:

- Yellow: Video
- Red: Audio, right channel
- White or black: Audio, left channel

Connect each plug to the corresponding connector on the component and on the TV.

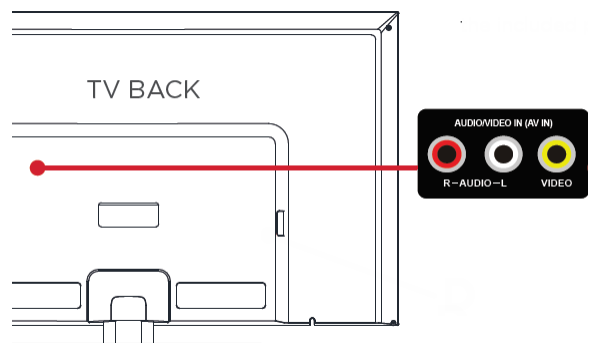

Connecting a component with an HDMI® cable

If possible, connect your devices using HDMI® cables (not provided). They provide the best video quality and also carry audio signals, so that only one cable is needed. For best picture quality, we recommend that you use cables designated as High Speed (Category 2) HDMI® cables.

Tip: You might need to configure the component to send its signal through its HDMI® connector.

The connector labeled **HDMI IN (ARC)** has the additional ability to use the audio return channel to send digital audio to a receiver or sound bar, as explained in “

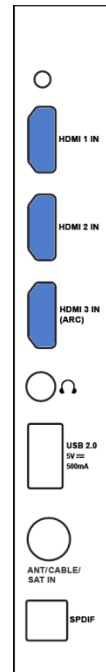

[Connecting an AV receiver or digital sound bar](#) on page [10](#).

Connecting headphones or analog sound bar

You can connect headphones or an analog sound bar (not provided) to the TV's headphone jack.

Tip: *Inserting a plug in the headphone jack disables the sound from the TV's built-in speakers.*



Connecting an AV receiver or digital sound bar to the TCL• Roku TV

You can enjoy Dolby Digital multichannel sound from your TV if you connect a digital amplifier in either of two ways:

- **Digital optical audio out (S/PDIF)** – Connect a TOSLINK optical cable (not provided) from the TV to the Optical input on your receiver or sound bar.
- **HDMI® ARC** – Connect an HDMI® cable (not provided) from the HDMI (ARC) connector to the HDMI® input on your receiver or sound bar. This connection uses the Audio Return Channel (ARC) feature of the HDMI® specification to output sound from the TV to a compatible device. To use this feature, you must configure the TV to enable HDMI® ARC, as explained in “[Enabling HDMI® ARC](#)” on page [63](#).

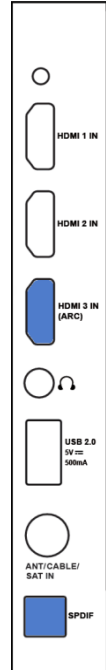

Preparing the TCL• Roku TV for Internet connectivity

If you want to connect your TV to the Internet to watch streaming content, you must connect using a wireless modem/router or a wireless access point. The TV connects through a built-in wireless LAN adapter. The TV does not support a wired connection or the use of a USB network adapter.

We recommend that your wireless connection support the IEEE 802.11b/g/n specification for the best experience.

AC power

Plug your TV into a power outlet. You can tell that the TV has power because the status light on the front of the TV lights up.

“[TCL• Roku TV status light](#)” on page [30](#) explains how the status indicator shows what is happening with the TV.

Remote control batteries

Open the back of your Roku TV remote control and insert two AAA batteries, observing the proper orientation. Reattach the back cover.

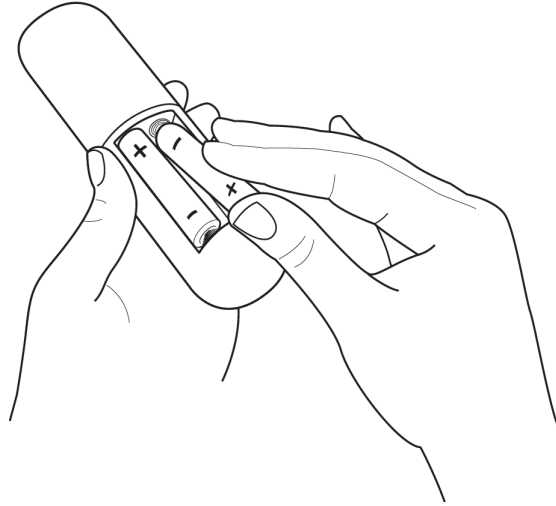

[“Roku TV Remote control”](#) on page [31](#) explains how to use the remote control in each of the TV’s operating modes.

Guided Setup

With the preliminaries out of the way, it's time to turn on your TCL• Roku TV. As the TV starts for the first time, it leads you through Guided Setup, which configures the TV before you start to use it.

During Guided Setup, you'll:

- Answer a few questions
- Provide network connection information
- Get a software update
- Link your Roku TV to your Roku account.
- Connect devices such as a DVD player, game console, or cable box.

Note: *Guided Setup only runs the first time you turn on your Roku TV. If you need to run Guided Setup again, you'll have to perform a factory reset, as explained in "[Factory reset everything](#)" on page [65](#).*

Starting Guided Setup

To start Guided Setup, press the **POWER** button on the remote control to turn on your Roku TV.

When you first turn on your TV, it will take a few seconds to get itself ready. You'll notice the following things happening:

1. The status light blinks every time the TV is busy doing something; in this case it's powering up and getting ready for you.
2. The power-on screen appears and the status light blinks slowly for a few more seconds. The power-on screen displays a TCL• Roku TV logo while the TV starts up.

3. After a few seconds, Guided Setup starts:

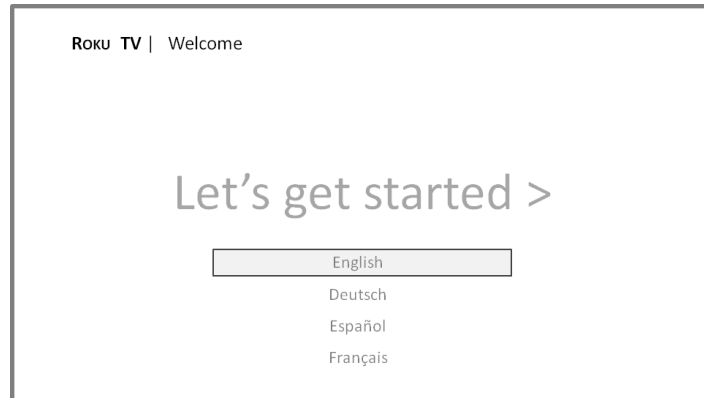

Setting up your TCL• Roku TV

With the first Guided Setup screen on your TV, follow these steps to set it up:

1. Press **OK** or **RIGHT** on the remote control to go to the next screen:

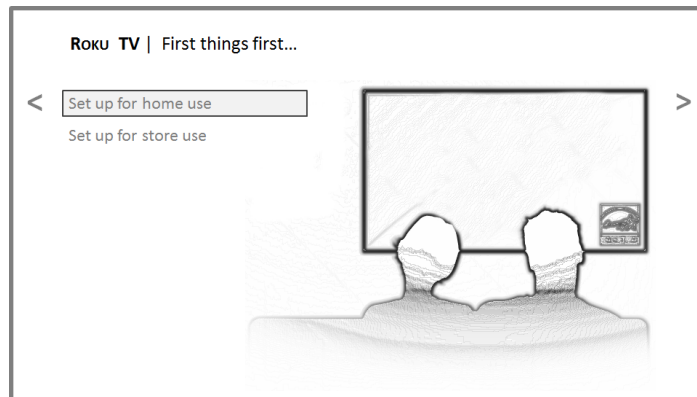

2. Press **OK** to select **Set up for home use**. Home mode is the right choice for enjoying your TV. It provides energy saving options as well as access to all features of the TV.

Note: *Store mode configures the TV for retail display and is not recommended for any other use. In store mode, some features of the TV are missing or limited. To switch from one mode to the other, you have to perform a factory reset as explained in "[Factory reset everything](#)" on page [65](#), and then repeat Guided Setup.*

After you select **Set up for home use**, the TV scans for the wireless networks within range and displays them in order, with the strongest signals first. In addition to your own wireless signal, the TV might pick up signals from your neighbors.

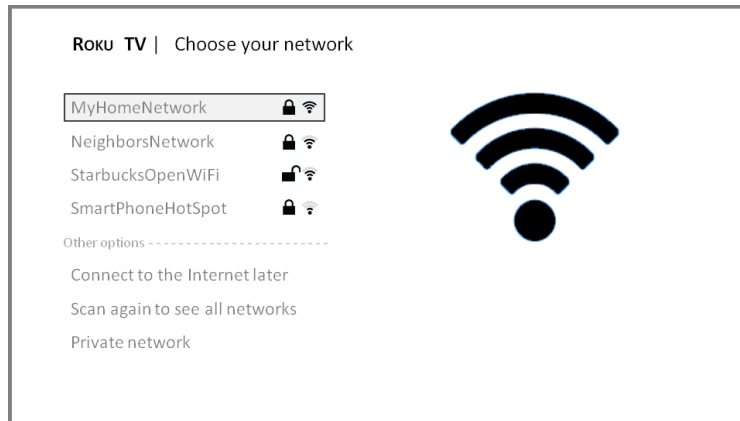

3. Press **UP** or **DOWN** to highlight the name of your wireless network, and then press **OK** to select it.

Other options:

- **Connect to the Internet later** – If you're unable to connect to the Internet, that's OK. You can skip this step and use the TV to watch broadcasts, play games, and watch DVDs. If you want to connect later, it's easy. We'll show you how in "[Benefits of connecting](#)" on page [23](#). Connecting the TV enables you to choose from thousands of streaming channels so the TV really wants you to connect, and will try a couple more times to convince you that connecting is a good idea.

Note: *If you decide not to connect, Guided Setup skips ahead to setting up the devices that you've connected to your TV. See "[Non-connected TCL• Roku TV Home screen](#)" on page [22](#) to get started using your non-connected TV.*

- **Scan again / Scan again to see all networks** – This option depends on the number of wireless networks within range.
 - **Scan again** appears if the list already shows all available wireless networks within range. If you don't see your wireless network name in the list, you might need to adjust the location of your wireless router or the TV, turn on your router, or make other changes. When everything is ready, select **Scan again** to see if your network name now appears in the list.
 - **Scan again to see all networks** appears if the TV finds more than seven wireless networks, because the TV initially displays only the strongest seven networks. If you don't see your wireless network name in the list, this option displays the complete list. If you still don't see your network name, you might have your router configured to provide wireless service as a "private network."

Note: Highlighting either of these options displays an informational panel with the unique media access control (MAC) address of your Roku TV. You will need the MAC address if your wireless router is configured to use MAC address filtering.

- **Private network** – If your wireless network name is hidden, it won't appear in the list. Select **Private network** to display an on-screen keyboard, and use it to enter your network name. Unless you changed the factory-set network name, you can find the name (also called SSID) on a label on the router.

Tip: Wireless networks that are password-protected display a “padlock” icon adjacent to the name.



4. If your network is password-protected, an on-screen keyboard appears. Use the keyboard to enter the network password.

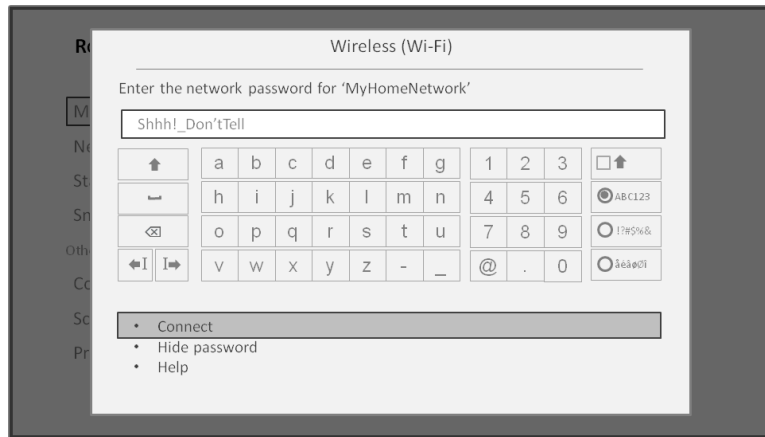

5. After you submit your network password, the TV displays progress messages as it connects to your wireless network, your local network, and the Internet.
6. Your TV needs to know the local time zone so that it can correctly display time information about the program you are currently watching. If the TV is unable to automatically determine the local time zone, it prompts you to choose your time zone from a list. Use the **UP** and **DOWN** buttons to highlight your time zone, and then press **OK**.

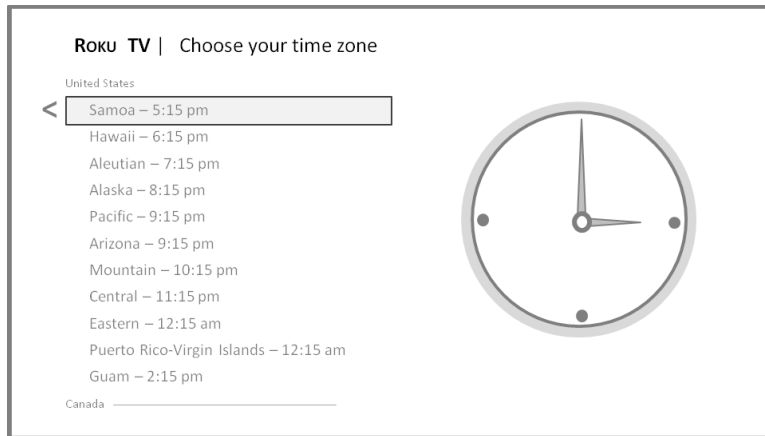

- As soon as the TV is able to connect to the Internet, it downloads and installs its first software update, and then restarts.

Tip: Your TV automatically checks for updates periodically. These updates provide new features and improve your overall experience with the TV. After an update, you might notice that some options have moved, and that there are new options or features.

You can download an updated User Guide that matches your Roku TV software version from the TCLweb site at:

www.TCLUSA.com/support

To determine your current Roku TV software version, go to **Settings > System > About** after you complete Guided Setup.

After the TV restarts, it displays the **Activation** screen:

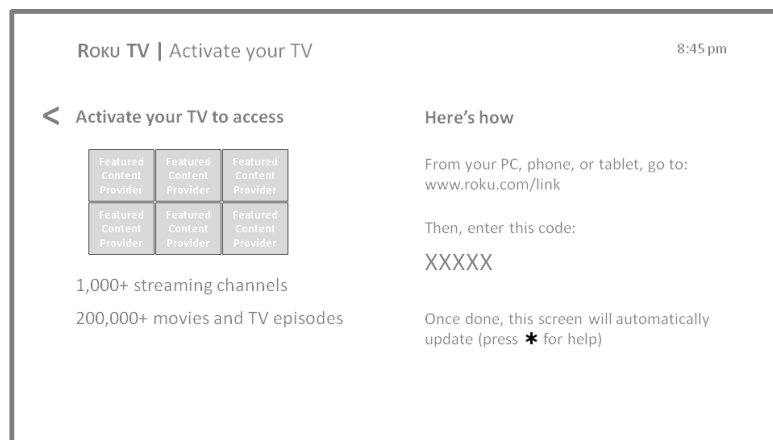

- Using a computer, tablet, or smartphone with an Internet connection, go to the web address displayed on the screen and enter the code that appears on your screen.

After you log in or create your Roku account, the TV gets an acknowledgement and adds your preexisting streaming channels, if any, to your Roku TV. This process is automatic and takes a few moments—a little longer if you already have a lot of streaming channels to add.

Tip: *Streaming channels from all Roku devices associated with your account are synchronized periodically, so all of your Roku devices have the same streaming channels (subject to compatibility with the device).*

Note: *Channel availability is subject to change and not all content is available in countries or regions where Roku products are sold.*

Why do I need a Roku Account?

You need a Roku Channel Store account for several reasons.

- It links you, your Roku TV and your other Roku devices to the Roku Channel Store and billing service.
- Streaming content providers know that it's OK to send content you request to your Roku TV.
- Roku can automatically send updates to your device.

Important: It doesn't cost anything to use and maintain your Roku Channel Store account (other than the cost of the TV and Internet access). Your Roku TV is packed with hundreds of free channels. Adding a payment method now lets you easily rent or buy movies on demand, or try popular streaming channels.

After it adds your selected streaming channels, the TV helps you set up the devices that you're connecting to it, such as a cable box, Blu-ray player, or game console:

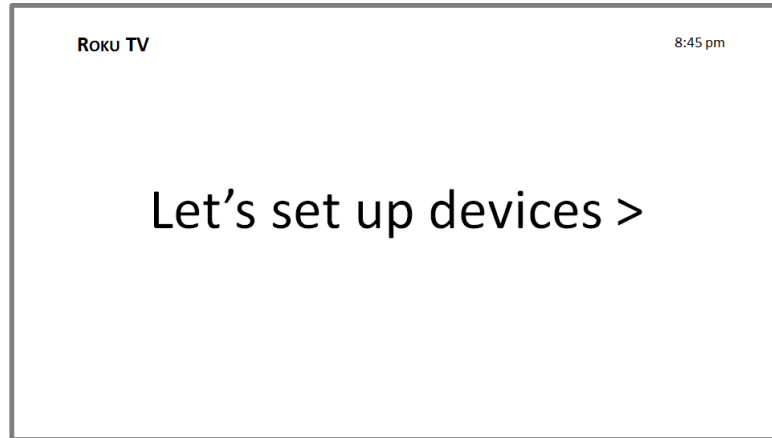

9. Press **OK** or **RIGHT** to proceed:

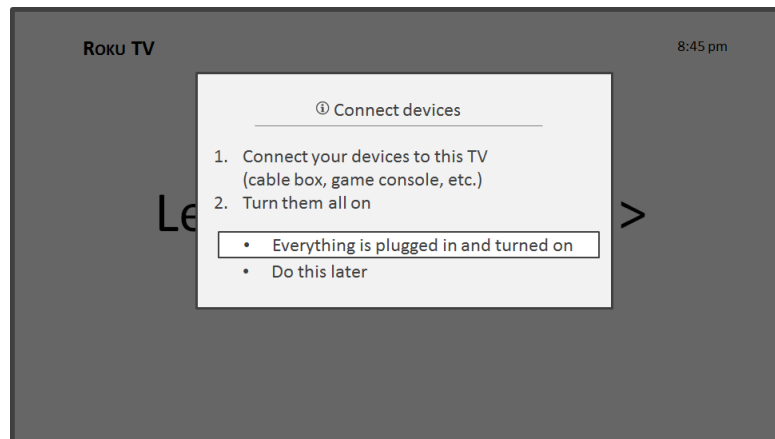

10. Connect all the devices you plan to use with your TV, turn them all on, and then select **Everything is plugged in and turned on**. The TV now takes you step by step through each of its inputs and asks what kind of device you have connected. On each input that has a connected and active device, you can see its picture and hear its sound.

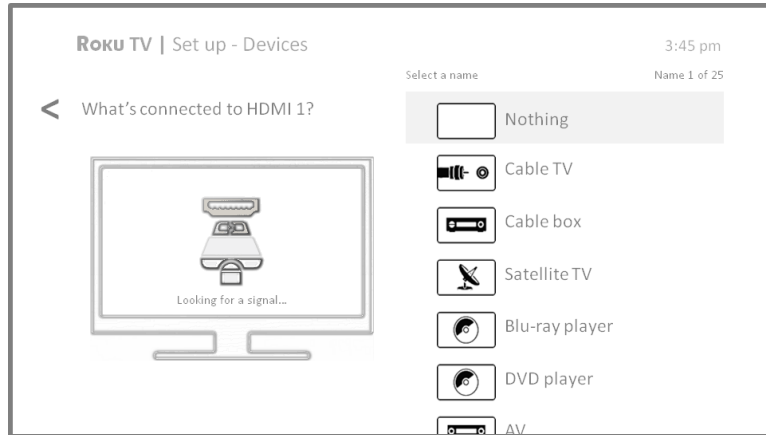

11. Press **UP** or **DOWN** to highlight the label you want to associate with the input, and then press **OK** to move on to the next input.

You're done with Guided Setup.

If your TV is connected to the Internet: To ensure you have a great Roku TV experience, we'll show you an introductory video filled with some great hints and tips. If you're not interested, press  on the remote control to exit the video and go to the Roku TV **Home** screen.

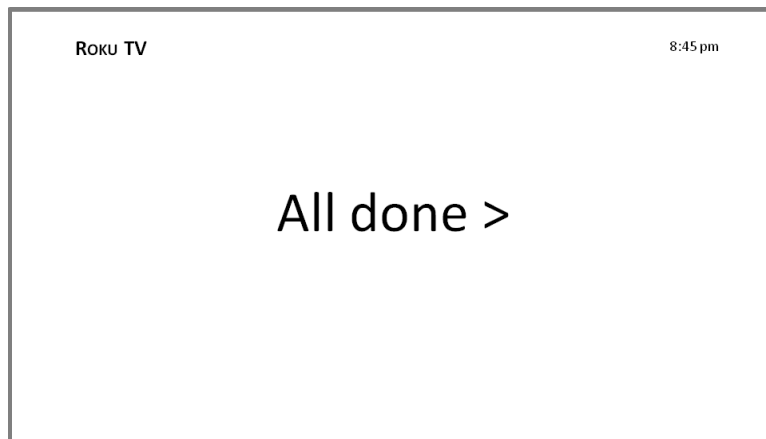

When you finish Guided Setup, and whenever you press  on the remote control, the **Home** screen greets you.

From here, you can explore everything your TV has to offer. Press the arrow buttons to move around, and press **OK** to select a highlighted item. We've designed the TV to encourage you to explore, and you can probably figure out most of the capabilities and settings on your own. If you have any questions or difficulties, you can find answers and solutions in this guide.

If you find yourself a long way from the **Home** screen, you can always get back right away by pressing one button: 🏠.

Connected TCL• Roku TV Home screen

Here is a typical **Home** screen from a Roku TV that's connected to the Internet and paired with a Roku account.

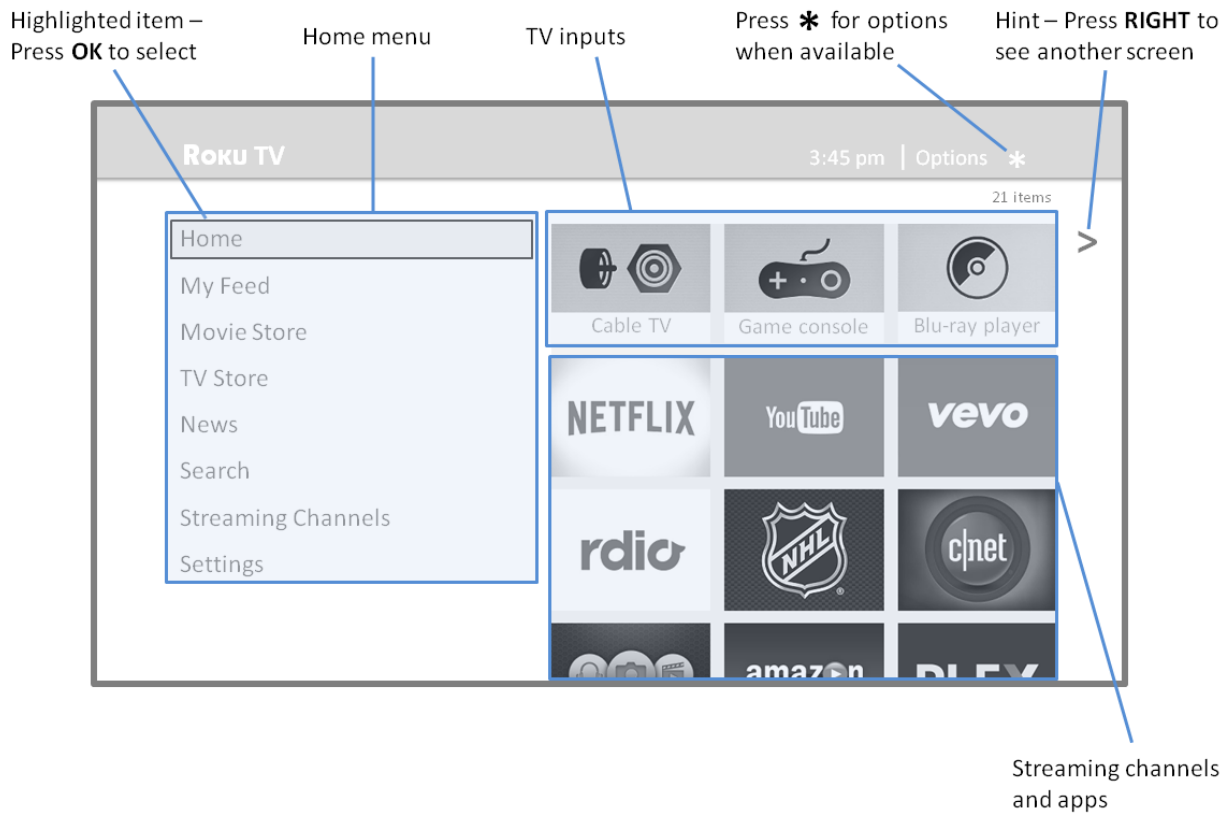

Connected Home Screen, United States markets

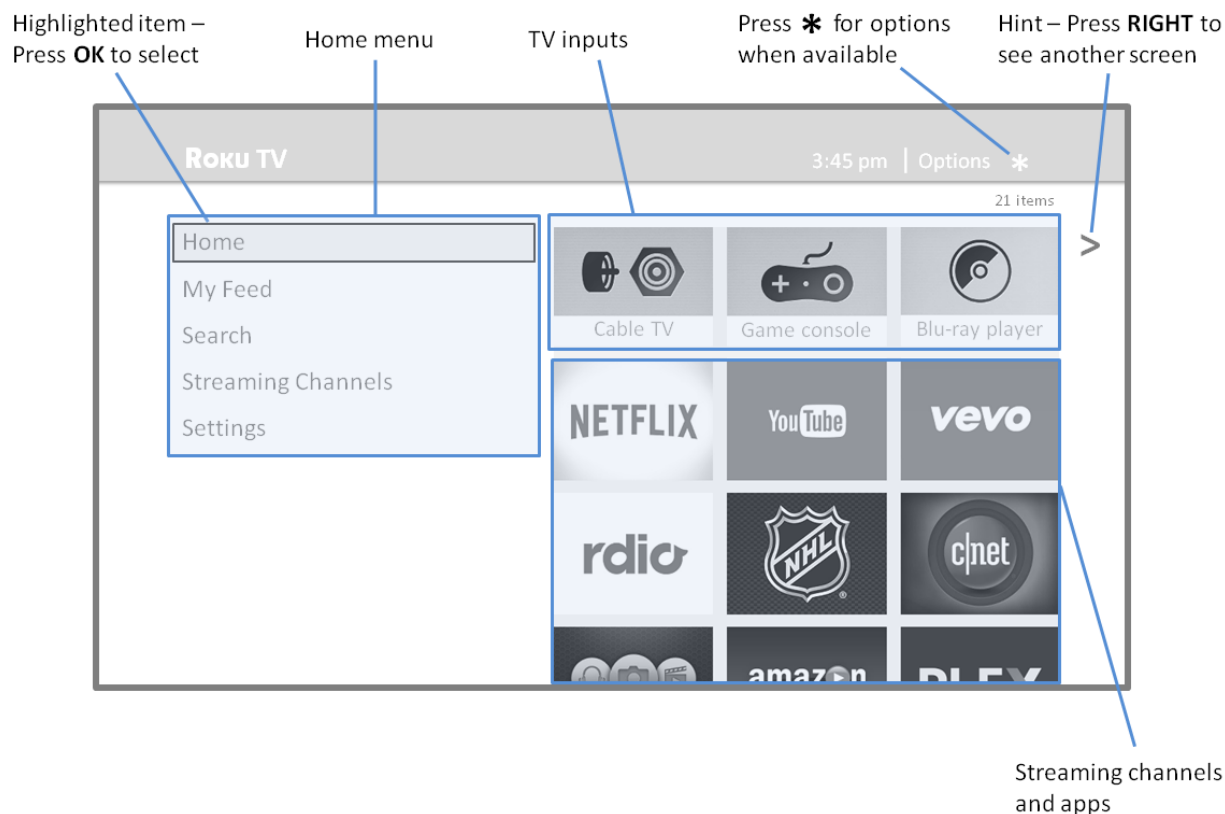

Connected Home Screen, Canadian markets

Personalize your Home screen

You can do a lot to personalize your **Home** screen and make it just right for you and your family:

- Add streaming channels by using the **Streaming Channels** menu option to browse the Roku Channel Store.
- Remove a tile by highlighting it and pressing *****. Then highlight **Remove input** or **Remove channel** and press **OK**.
- Reposition a tile by highlighting it and pressing *****. Then highlight **Move input** or **Move channel** and press **OK**. Use the arrow buttons to move the tile, and then press **OK** to lock it in its new location.
- Rename a TV input tile by highlighting it and pressing *****. Then highlight **Rename input** and press **OK**. Highlight a new name in the list, and then press **OK** to assign that name to the tile.
- Change the screen theme by going to **Settings > Themes** to find and pick one to suit your mood.
- Hide Movie Store, TV Store, or News, (US models only) as explained in [“Blocking Movie Store, TV Store, and News”](#) on page .

Non-connected TCL• Roku TV Home screen

Here is a typical **Home** screen from a Roku TV that is not connected to the Internet.

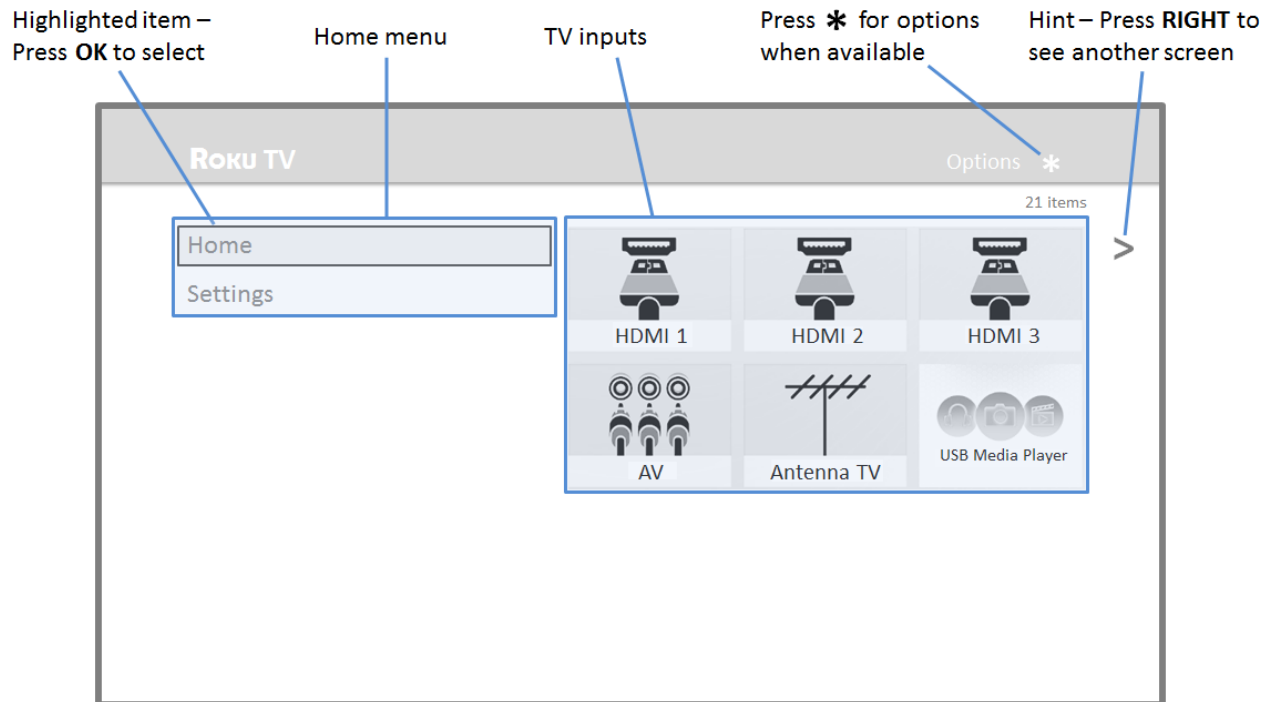

Personalize your Home screen

You can do a lot to personalize your **Home** screen and make it just right for you and your family:

- Remove a tile by highlighting it and pressing *****. Then highlight **Remove input** and press **OK**.
- Reposition a tile by highlighting it and pressing *****. Then highlight **Move input** and press **OK**. Use the arrow buttons to move the tile, and then press **OK** to lock it in its new location.
- Rename a tile by highlighting it and pressing *****. Then highlight **Rename input** and press **OK**. Highlight a new name in the list, and then press **OK** to assign that name to the tile.
- Add streaming channels by browsing the Roku Channel Store (after connecting the TV to the Internet to add the **Streaming Channels** option to the menu).

Benefits of connecting

Connecting brings out your TCL• Roku TV's full potential!

Make any night a movie night

Thousands of movies to choose from, across all major streaming movie channels like Netflix, Cineplex Store, Crackle, and more*. You'll never run out of something new to watch.

Get in the groove

Stream endless hours of music from channels like Spotify, VEVO, and Rdio. With on-demand access to thousands of music artists, your favorite beats are just as close as your remote.

Explore your passions

In addition to popular streaming channels like YouTube, NHL, Sky News and Cineplex Store, your Roku TV also offers hundreds of streaming channels to fuel your passions—including fitness, cooking, religion, outdoors, International programming and much more.

Enjoy FREE trials of popular channels

Your Roku TV comes loaded with special offers, including free trials from popular streaming channels Netflix, Spotify, Rdio, DailyBurn Fitness, and many more.

What is streaming?

Streaming is viewing or listening to video or audio content that is sent over the Internet, or located on a network-connected media server or on a USB device plugged into the TV's USB port.

With streaming, you can watch most programs on demand, when it's convenient for you. When streaming, you can play, pause, rewind, and fast forward whatever you are watching. You can also replay the last few seconds again, or turn on closed captions.

* Subscription or other payment may be required to access certain channels. Content may not be available in all areas in which the TCL• Roku TVs are sold and channel availability is subject to change.

Tip: *Some content cannot be paused or skipped. For example, if you are viewing live programming or a program that is supported by ads, you generally are not allowed to skip the ads.*

Your Roku TV lets you choose from thousands of streaming channels that offer a huge selection of entertainment:

- Thousands of movies and TV episodes
- Unlimited music, live and on-demand
- Tons of live and on-demand sports
- Commercial-free kids programming
- International programming in 22 languages
- 24x7 news and in-depth news commentary

Many streaming channels are free. Some streaming channels, like Cineplex and Amazon Instant Video, let you purchase or rent the latest movie releases or popular TV series. Some channels such as Netflix or Spotify charge a monthly subscription fee and others are free if you subscribe to a companion service through your cable or satellite provider. For example, HBO subscribers with participating broadcastTV provider accounts can add the HBO Go channel and watch it for free.

If you have an existing subscription to a service like Netflix or Spotify, you can just sign in with your existing user name and password.

To play streaming content that is available on the Internet, you add streaming channels to your **Home** screen. To add a streaming channel to your **Home** screen, use the **Streaming Channels** option on the **Home** screen menu to go to the Roku Channel Store, and then select the streaming channel you want to add. The streaming channel is then added to your **Home** screen, and you can watch it at any time.

For more information on using the Roku Channel Store feature, see "[Using the Roku Channel Store](#)" on page [46](#).

Note: *Subscription or other payment may be required to access certain content. Channel availability subject to change without notice. Some channels may not be available to all households in every market or in all countries where Roku TVs are sold.*

But what if I didn't connect my TCL• Roku TV?

What if you went through Guided Setup and chose **Connect to the Internet later**? No worries. Your Roku TV makes it easy to connect whenever you want. As you move around the **Home** screen, you'll see several places where you can start the connection process. For example:

- Now and then you'll see a message appear on the panel to the right of the **Home** screen offering a **Connect Now** option. Simply highlight and select the **Connect Now** option to get started.

- Use the **Connect and activate now** option in the **Settings** menu. From the **Home** screen menu, select **Settings**, then **Network**, and then **Connect and activate now**.
- If you want to start over from the beginning, use the **Settings** menu to do a **Factory reset**, and then go through Guided Setup again. This time, choose your home network when prompted.

Regardless of how you connect, the process is the same. If you need details, see Step [3](#) on page [14](#)

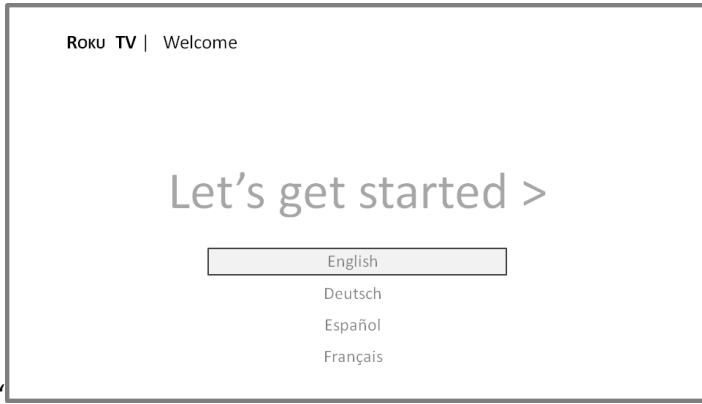

under “

[Setting up your TCL• Roku TV.](#)”

Setting up Antenna TV

Despite all of the entertainment possibilities of your Roku TV, you may also want to watch broadcast TV. You watch broadcast TV in much the same way you watch other entertainment choices. You select a tile—the **Antenna TV** tile—from the **Home** screen.

The first time you select the **Antenna TV** tile, you have to set up the TV tuner. Setting up the TV tuner scans for active channels and adds them to your broadcast TV channel list.

Why do I have to set up the TV tuner?

You might be asking, “Why is this step necessary?” Good question.

Not everyone needs to use the TV tuner. For example, you might have a set top box provided by a cable or satellite company that receives all of your channels. Most of these set top boxes use an HDMI[®] connection.

More and more people are watching only streaming TV and do not have a TV antenna or cable/satellite service. If you don’t need the TV tuner, you can bypass setting it up and instead remove it from the **Home** screen as explained in [“Remove unwanted tiles”](#) on page [49](#).

When you set up Antenna TV, the TV scans the signals on its antenna input for channels with a good signal, and adds those to the channel list, skipping dead channels and channels with a very weak signal.

The TV will, however, let you add two analog channels, even if they have no signal. You might need to add these channels if you have an older set top box, VCR, or game console that can only output a signal on analog channel 3 or 4. These are the only channels that can be added regardless of whether they have a good signal. Typically, you’ll only need one of these channels, but both are provided to make setup simpler. You can hide the one you don’t want as explained in [“Edit broadcast TV channel lineup”](#) on page [48](#).

How do I set up the TV tuner?

Setting up the TV tuner is easy—your TV does most of the work. You just have to answer a couple of questions.

1. Make sure your antenna (sold separately) or TV cable is connected to the TV’s **ANT/CABLE** input.

2. On the **Home** screen, select the **Antenna TV** tile.
3. Read the simple on-screen instructions and select **Start setup**.



4. If prompted, select your time zone. You'll only need to do this if the TV can't figure out your time zone from your Internet connection.

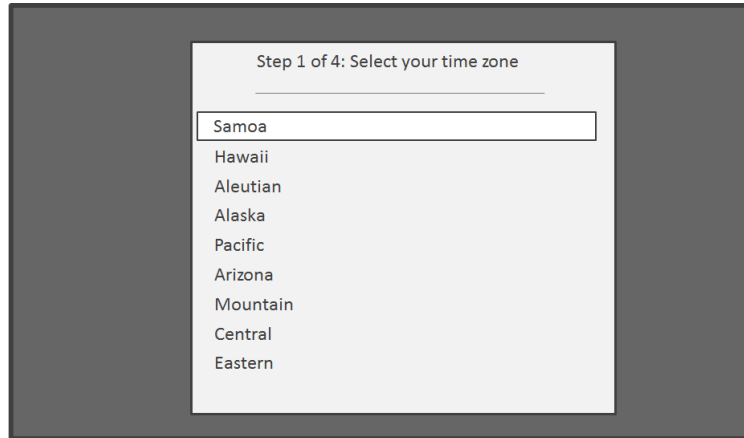

Why does the TV need my time zone?
The TV needs to know your time zone so that it can correctly display time information about the program you are currently watching.

5. When prompted, select whether to add analog channels 3 and 4 (to enable you to connect older set top boxes, VCRs, or game consoles).

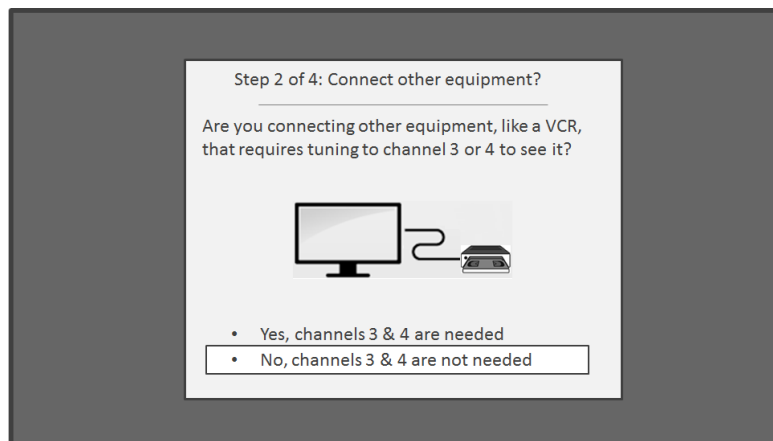

6. Wait while your TV scans for broadcast (antenna TV) stations...

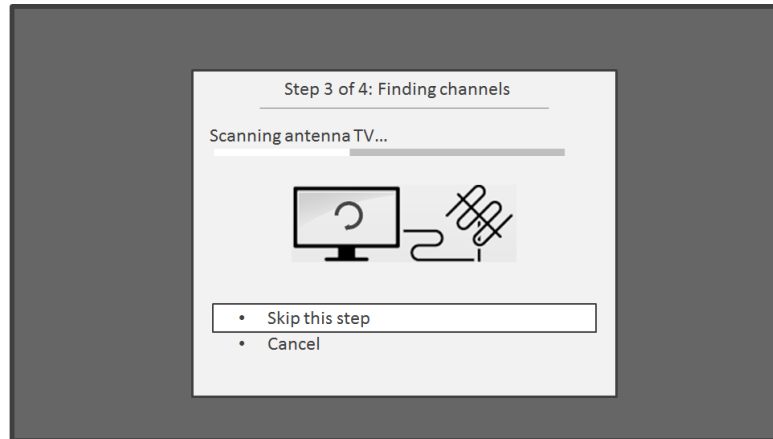

... and then cable TV channels.

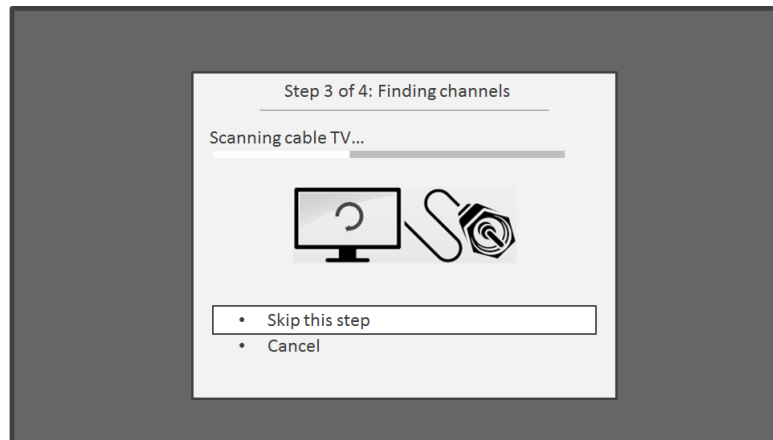

Tip: Cable TV channels are channels from a cable TV provider that you can receive by connecting their cable directly to your TV (unscrambled NTSC, ATSC, and QAM channels, if you're the kind of person who is interested in the details). In many cases, your cable provider probably requires you to use their set-top box and connect it to a different input, and then use the set-top box to tune your cable stations. In that case, you can skip scanning for cable channels.

7. When the channel scans finish, the TV shows the number of channels it added.

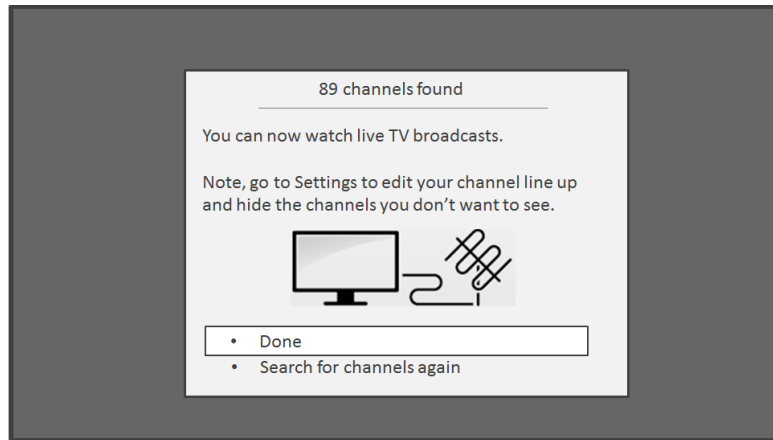

Scanning for channels can take several minutes.

Tip: Repeat the channel scan from time to time to make sure you are receiving all of the latest channels. Broadcasters add and remove channels, move channels to different parts of the spectrum, and change the power levels of their channels periodically.

Note: You'll have to repeat the channel scan if you remove the **Antenna TV** tile from the **Home** screen or perform a factory reset. To repeat the channel scan at any time, go to **Settings > TV inputs > Antenna TV > Scan again for channels**. Your antenna reception and picture quality depend on the position of your antenna and on your location relative to the antennas of broadcasters in your area.

Now, you're ready to watch broadcast TV! While you're watching, try the following:

- Press **UP** or **DOWN** to change channels.
- Press **LEFT** to display the channel list and then use UP and DOWN to select a channel to watch. Or press **REWIND** or **FAST FORWARD** to jump through the channel list a page at a time.
- Press **OK** to display information about the current program.
- Press ↶ to switch to the previously tuned channel.
- Press ***** to see options for picture and sound settings.

Note: If ↶ is not available on your remote control, you can use ↶ on the Roku App or the Jump Back button on a universal remote. For more information, see "[Other devices](#)" on page [69](#).

["Roku TV Remote control"](#) on page [31](#) has more information on using the remote control buttons while watching TV.

Using your TCL• Roku TV

This section provides information on using the day-to-day features of your TCL• Roku TV.

TCL• Roku TV status light

Your TV has a single status light on the front panel. It goes on and off and blinks in different ways depending on the status of the TV, as shown in the following table:

TV condition	Status indicator	Meaning
On (screen is active)	Off	Screen is communicating that TV is on.
Screensaver (screen is active)	Off	Screen is communicating that TV is on.
Off (no power)	Off	TV is not connected to power.
Off (standby)	On	TV is connected to power and is ready to use.
Starting up from off state	Slow pulsing blink until startup completes	TV is doing something.
On (receiving update from USB)	Slow pulsing blink until update completes	TV is doing something.
Remote control command received	Dims on/off once	TV has received your command.
Powering down to standby mode	Slow pulsing blink until the TV reaches standby.	TV is doing something.

TCL• Roku TV panel buttons

The controls on the TV enable you to perform simple functions, but are not a substitute for the remote control. The joystick-type control on the back of your TV near the lower right side provides the following functions:



- Press in to toggle between power ON and Standby.
- Press up or down to increase/decrease the volume.
- Press left or right to switch inputs.

Standby mode energy savings

About 10 minutes after you turn off your Roku TV, it goes into a very low power standby mode. Until that happens, if you turn on the TV again, it immediately displays the activity you selected in the **Power on** settings, as described in “[Power on settings](#)” on page [50](#). After the TV goes into the low power standby mode, it takes a bit longer to start up.

Roku TV Remote control

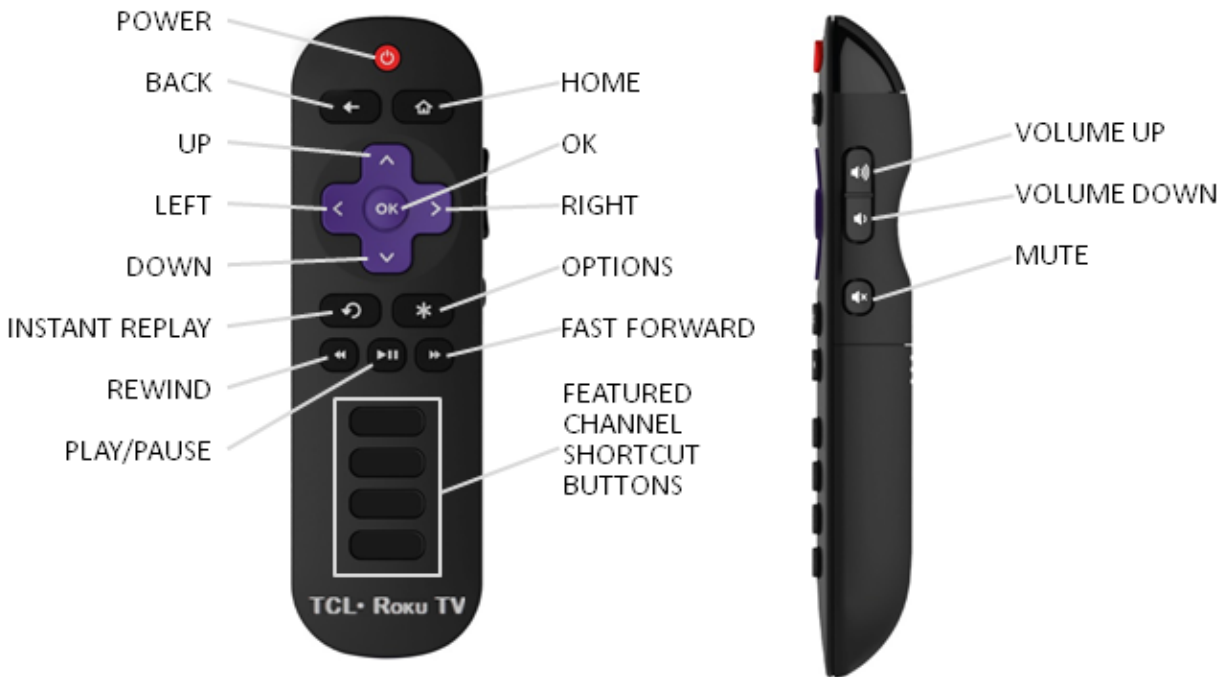

TCL• Roku TV IR remote control

Getting around

You've already done a bit of navigating with the remote control when you completed the Guided Setup and when you set up Antenna TV. This section explains how to use the remote control for everyday TV use.



POWER

If the TV is in Standby mode, turns power on.

If the TV is on, puts TV in Standby mode.



BACK

The action depends on what you are doing with the TV:

- **Menu:** Goes back to previous menu/screen.
- **Home screen tile:** Moves highlight back to the **Home** menu option.
- **Watching Antenna TV or a TV input:** Returns to the screen from which the input was selected.
- **Playing streaming content:** Stops playing stream and returns to the previous menu or screen.
- **Browsing streaming content:** Goes to the previous level in the content tree.



HOME

Immediately returns to the **Home** screen menu.



OPTIONS

Displays an **Options** menu, but only when the **Options *** hint in the upper right corner of the screen is not dimmed. The menu you see varies depending on what you are doing with the TV.

Also, in most cases, pressing ***** while video is playing displays an **Options** menu over part of the screen where you can adjust various picture and sound settings.



UP

Moves the highlight up one item.



DOWN

Moves the highlight down one item.



LEFT

Moves the highlight left, if possible (if a **<** hint appears).

When watching TV, displays your channel list.

When playing most streaming videos, skips backward in the video.



RIGHT

Moves the highlight to the right, if possible (if a **>** hint appears).

When watching TV with the channel list displayed, dismisses the channel list.

When playing most streaming videos, skips forward in the video.

**OK**

Selects the highlighted option.

When watching TV, this button displays information for the current TV program.

**REWIND**

When playing streaming video that supports this feature:

- First press rewinds at 1x speed.
- Second press rewinds at 2x speed.
- Third press rewinds at 3x speed.
- Subsequent presses cycle through 1x, 2x, and 3x rewind speed.

When playing streaming audio, jumps to the previous track/selection.

When any menu, tile, or channel in the channel list is highlighted, jumps up one page.

When using a virtual keyboard, jumps to the character at the top of the current column.

**PLAY/
PAUSE**

When playing streaming content, alternately pauses and plays the content.

**FAST
FORWARD**

When playing streaming video that supports this feature:

- First press fast forwards at 1x speed.
- Second press fast forwards at 2x speed.
- Third press fast forwards at 3x speed.
- Subsequent presses cycle through 1x, 2x, and 3x fast forward speed.

When playing streaming audio, jumps to the next track/selection.

When any menu, tile, or channel in the channel list is highlighted, jumps down one page.

When using a virtual keyboard, jumps to the character at the bottom of the current column.

**INSTANT
REPLAY**

When playing streaming video that supports this feature, jumps back a few seconds with each press and resumes playing. In some channels, if **Closed captioning** is set to **Instant Replay**, captions are displayed during the duration of the jump back period only.

When watching broadcast TV, jumps to previous channel.

When using an on-screen keyboard, backspaces in the text you are entering.



VOLUME UP

Turns volume up one setting with each press. Press and hold to turn volume up rapidly. A volume indicator shows the volume level while you are adjusting the volume and for a few seconds afterward.

Note: *If the TV is muted, pressing **VOLUME UP** unmutes the sound.*



VOLUME DOWN

Turns volume down one setting with each press. Press and hold to turn volume down rapidly. A volume indicator shows the volume level while you are adjusting the volume and for a few seconds afterward.

Note: *If the TV is muted, pressing **VOUME DOWN** does not unmute the sound.*



MUTE

Mutes and unmutes the TV sound. A volume indicator shows the current volume level and a mute icon when you press **MUTE** and for a few seconds afterward. If **Closed captioning** is set to **When Mute**, captions are displayed while the TV is muted.



FEATURED CHANNEL SHORTCUT

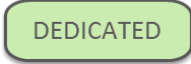
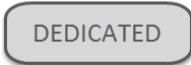

Dedicated buttons show the logo of a featured streaming content provider. Pressing a button turns the TV on (if the TV is not already on), and if the TV is operating in connected to the Internet, performs one of the following actions:

- Displays the streaming channel’s main page if you have already added the channel to your **Home** screen.
- Displays the streaming channel’s sign-up page if you have not already added the channel so that you can agree to any terms and fees for the service.

Watching broadcast TV channels

To watch broadcast TV, select the **Antenna TV** tile in the **Home** screen. Your TV remembers the last channel you watched and starts with that channel playing.

Tip: *You also can use the buttons on the TV panel to select Antenna TV, as explained in "[TCL Roku TV panel buttons](#)" on page [30](#).*

Changing channels

To change channels, you can do any of the following:

- Press **UP** to change to the next higher channel.
- Press **DOWN** to change to the next lower channel.

- Press **LEFT** to display the channel list, and then press **UP** and **DOWN** to move the highlight through the list one channel at a time. Or press **REWIND** and **FAST FORWARD** to move the highlight through the list one page at a time. When you've highlighted the channel you want to watch, press **OK**. (If you decide you don't want to change channels, press **RIGHT** or **BACK**).
- Press ↶ to jump to the previous channel. Press again to return to the channel you were watching before you pressed ↶.

Note: If ↶ is not available on your remote control, you can use ↶ on the Roku App or the Jump Back button on a universal remote. For more information, see "[Other devices](#)" on page [69](#).

Viewing program information

To view information about the current program, press **OK**. The TV displays a banner at the bottom of the screen with as much information as is available in the program data stream.



Program information banner

Program information, subject to availability, includes:

- Channel number
- Channel call sign
- Signal strength
- Program title
- Start time, end time, and graph of program length showing current position
- Content rating
- Video resolution (480i, 480p, 720p, 1080i, 1080p)
- Audio quality (Mono Dolby Digital, Stereo Dolby Digital, 5.1 Dolby Digital, Dolby Digital+)
- Audio features (SAP)
- Closed captioning (CC)
- Current time

- Program description. If the entire description does not fit, press **OK** to expand the size of the banner and see the entire description.

Adjusting settings

Press ***** to display the **Options** menu. Press **UP** and **DOWN** to highlight an option, and then press **LEFT** and **RIGHT** to change the setting. “[Adjusting TCL• Roku TV settings](#)” on page [38](#) explains each of the settings in detail.

Switching TV inputs

Switch to a TV input to access the device connected to that input, for example, a Blu-ray player. Switching inputs is as simple as highlighting the input’s tile in the **Home** screen, and pressing **OK**. The video signal on the input, if any, appears on the screen.

***Tip:** You also can use the buttons on the TV panel to select a TV input, as explained in “[TCL• Roku TV panel buttons](#)” on page [30](#). “[Customizing your TCL• Roku TV](#)” on page [47](#) explains how to rename and remove inputs.*

Auto-detecting devices

Your TV automatically detects when you connect a new device to an HDMI[®] input and turn on its power. The input is automatically added to the **Home** screen if it isn’t already present.

Adjusting audio/video settings

While watching video content on any input, press ***** to display the **Options** menu. Press **UP** and **DOWN** to highlight an option, and then press **LEFT** and **RIGHT** to change the setting. “[Adjusting TCL• Roku TV settings](#)” on page [38](#) explains each of the settings in detail.

Playing content from USB storage devices

Your TV has a USB port that can be used to play personal music, video, and photo files from a USB flash drive or hard disk. If your TV is connected to the Internet, your **Home** screen has the **Roku Media Player** tile. If your TV has not been connected to the Internet, the **Home** screen has the **USB Media Player** tile.

To use this feature, first make sure your media files are compatible with the Roku/USB Media Player. As of the publication date of this guide, the following media file formats are supported*:

- **Video** –MKV (H.264/262), MP4, MOV (H.264)
- **Music** – AAC, MP3, WMA, WAV (PCM), AIFF, FLAC, AC3, and DTS†
- **Photo** – JPG, PNG (up to 4k x 4k pixels), GIF (up to 4k x 4 k pixels)

To see the latest list of supported formats, view **Help** in the Media Player.

The Roku/USB Media Player displays supported file types* only, and hides file types it knows it cannot play.

Playing content from local network media servers

If you have connected your TV to a network, it can play personal video, music, and photo files from a media server on your local network. Media servers include personal computers running media server software such as Plex or Windows Media Player, network file storage systems that have built-in media server software, and other devices that implement the specifications of the Digital Living Network Alliance. Some servers do not fully implement the DLNA specification but are UPNP (Universal Plug and Play) compatible. The Roku Media Player will connect to them as well.

Some media servers can convert files into Roku compatible formats. DRM-protected content is not supported.

* There are many variants of each of these media formats. Some variants may not play at all or may have issues or inconsistencies during playback.

† DTS audio, whether in music or video files, is supported only by pass-through, meaning that the TV cannot directly output the sound of a DTS file, but can pass it through to a DTS-compatible receiver that is connected to the HDMI ARC or S/PDIF connector on the TV.

Adjusting TCL• Roku TV settings

You can adjust most picture and sound settings while you are watching a program by pressing ***** to display the **Options** menu. If you don't find what you need, there are additional picture and sound settings in the **Settings** menu.

In most cases, the changes you make apply only to the input you are using. Antenna TV, each separate HDMI[®] input, and the AV input have their own settings that the TV remembers when you return to that input. The TV also remembers the settings you specify while viewing streaming content.

Settings menu

Use the **Settings** menu to adjust overall TV settings. Press  to go to the **Home** screen, and then navigate to **Settings > TV picture settings**.

You can adjust the following overall TV picture settings from the **Settings screen**:

- **TV brightness** – If the lighting level in your TV room changes, use this setting to help provide a better viewing experience; set to darker for a darker room, and brighter for a brighter room. Choose among **Normal** and four other settings to make the overall picture brighter or darker. So that you don't have to make this type of change for each TV input one at a time, this setting increases or decreases the TV's general brightness across all TV inputs. *This setting is identical to the **TV brightness** setting you can access in the **Options** menu while watching a program.*
- **Settings per input** – This section of options lists each TV input. Select an input to switch to that input. Then press ***** to display the **Options** menu, where you can adjust the input's settings while watching a live picture and listening to the sound from that input.

Tip: *You don't have to go to the **Settings** menu first—you can display an input's **Options** menu and adjust its settings whenever you are watching the input by pressing *****.*

Options menu

The **Options** menu for each TV input provides settings for controlling the appearance of the picture and the quality of the audio.

To view the **Options** menu, press ***** whenever you are watching a TV input or streaming a video. The **Options** menu is a panel that appears over the left side of the screen:

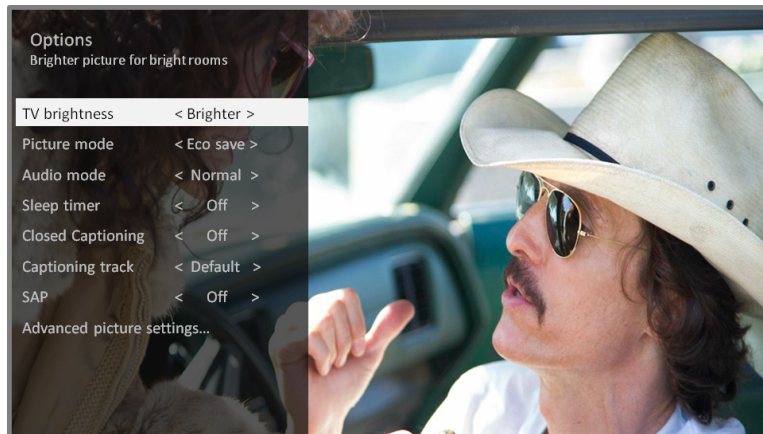

To adjust the settings on the **Options** menu, press **UP** or **DOWN** to highlight a setting, and then press **LEFT** or **RIGHT** to change the setting. You'll notice the changes you make right away in picture appearance or audio quality.

Tip: When you highlight a setting, the header text explains the effect of its current value. When you begin to adjust a setting, the other options are hidden so you can see more of the screen. Even though the other settings are hidden, you can move the highlight up or down to adjust the other settings.

Options menu settings

- **TV brightness** – Affects the overall brightness of the picture. *This setting applies across the entire TV; that is, to all TV inputs and is identical to the **TV brightness** setting in the **TV picture settings** menu.*
- **Picture mode** – Provides picture presets for various viewing preferences. *This setting applies to the currently-selected input only.*
- **Audio mode** – Adjusts the sound quality output from the TV speakers. *This setting applies across the entire TV; that is, to all TV inputs.* It does not affect the sound quality for headphones, HDMI (ARC), or SPDIF (TOSLINK) connectors.
- **Sleep timer** – Sets a timer that turns off the TV after the specific amount of time. *This setting remains in effect even if you stop watching the current input.*

- **Closed captioning** – Controls when you see captions. *This setting is only offered for Antenna TV, the AV input, and streaming videos. Any set value remains in effect across only these inputs.*
 - **Antenna TV** – Turn captions on or off, or set them to appear only when the TV sound is muted.
 - **AV input** – Turn captions on or off, or set them to appear only when the TV sound is muted.
 - **Streaming video channel** – Turn captions on or off, set them to appear only when the TV sound is muted, or only during instant replay (for streaming content that supports instant replay).

Note: *If the Instant Replay ↺ button is not available on your remote control, you can use ↺ on the Roku App or the Jump Back button on a universal remote. For more information, see “Other devices” on page 69. Additional captioning options are provided in the **Captions** screen in **Settings**.*

- **Captioning track** – Selects which caption track to display when Closed Captioning is on. *This setting remains in effect on all inputs that provide captions.*
- **SAP** – Selects whether to play a secondary audio program or multichannel television sound, and which choice to play. *This setting applies only to Antenna TV on digital channels.*

Tip: *To dismiss the **Options** menu, just wait a few seconds without pressing any buttons. Or press * again to dismiss the menu immediately.*

Advanced picture settings

The **Advanced picture settings** menu for each TV input provides settings for fine tuning the appearance of the picture. All of the settings in this menu apply only to the currently-selected input.

To use the **Advanced picture settings** menu, first press * to display the **Options** menu. Then select **Advanced picture settings**.



To adjust the settings on the **Advanced picture settings** menu, press **UP** or **DOWN** to highlight a setting, and then press **LEFT** or **RIGHT** to change the setting. You'll notice the changes you make right away in picture appearance.

***Tip:** When you highlight a setting, the header text explains the effect of its current value. When you begin to adjust a setting, the other options are hidden so you can see more of the screen. Even though the other settings are hidden, you can move the highlight up or down to adjust the other settings. As soon as you press **UP** or **DOWN**, the other settings become visible again.*

Advanced picture settings menu options

- **Picture mode** – Provides picture presets for various viewing preferences. This setting duplicates the one on the **Options** menu. When you change the **Picture mode**, other picture settings adjust accordingly. For example, setting the **Picture mode** to **Vivid** sets **Brightness**, **Contrast**, **Sharpness**, and other values to produce a very vibrant picture. Setting **Picture mode** to **Movie** changes these same settings to produce a picture suitable for enjoying movies in a darkened room. If you make changes to the individual picture settings—for example, **Contrast**, or **Sharpness**—these settings are saved for the current input *and* the current picture mode. In this way, the HDMI 1 input's **Movie** picture mode can be customized and different than the HDMI 2 input's **Movie** picture mode and Antenna TV's **Movie** picture mode. Use **Reset picture settings**, described below, to return the input's current picture mode to its original values.
- **Backlight** - Adjusts the overall light intensity of the screen.
- **Brightness** – Adjusts the dark level of the black areas of the picture.
- **Contrast** – Adjusts the white level of the light areas of the picture.
- **Sharpness** – Adjusts the sharpness of the edges of objects in the picture.
- **Color** – Adjusts the intensity of colors in the picture. A setting of 0 removes all color and displays a black and white picture.
- **Tint** – Adjusts the color balance from green to red to obtain accurate colors in the picture.
- **Color temperature** – Adjusts the overall colors in the picture from **Normal** to slightly more bluish (**Cool**) to slightly more reddish (**Warm**).
- **Picture size** – Adjusts the aspect ratio of the picture, enabling you to view a picture in its original format, or zoom or stretch it to fill the screen. The **Auto** setting has been found to produce the best picture in most cases.
- **Game mode** – Controls whether Game mode is on or off. When **On**, the TV performs less image processing and has less input lag. When **Off**, the TV may perform more image processing and has more input lag, which is less desirable for action games. *Available only for HDMI[®] and AV inputs.*
- **Reset picture settings** – Returns all picture settings for the input's currently-selected **Picture mode** to their original values.

Tip: To dismiss the **Advanced picture settings** menu, just wait a few seconds without pressing any buttons. Or press * again to dismiss the menu immediately.

The Roku Feed

Use The Roku Feed to find out when you can watch upcoming movies. The Roku Feed gives you updates on your list of movies that are coming soon to theaters. With The Roku Feed, you'll know when your favorite movie is ready to stream, the channels it is on, and how much it will cost. You also will be alerted any time a movie becomes available on another channel and whenever its price changes. When you see a movie that interests you, you can select **Follow this movie on Roku** to add it to **My Feed**.

Note: *When a movie you are following becomes available, the streaming channel offering the movie might require that you subscribe or pay a fee to view it.*

Tip: *The Roku Feed is available only if your TV is connected to the Internet.*

Searching for movies & shows

Searching for movies and shows across multiple streaming channels is one of the unique features of your Roku TV. Within a single search operation, you can search by:

- Movie name
- TV show name
- Actor or director name
- Streaming channel name
- Game name

Tip: *Roku Search is available only if your TV is connected to the Internet.*

Note: *Roku Search doesn't search across all streaming channels, but searches across lots of popular streaming channels. The actual channels it searches vary by locale, but include popular providers such as Netflix and several others, with more being added all the time.*

You can check which streaming channels are included in Roku Search by going to the **Search** screen, clearing all previous searches to reveal the search instructions, and then watching the channel tiles cycle at the bottom of the screen.

To search, select **Search** on the **Home** screen menu. The **Search** screen has a keyboard grid and initially displays instructions—a set of icons representing search categories and a list of participating provider tiles.

Tip: *If you don't see the instructions, navigate to the end of the list of recent searches and select **Clear recent search selections**.*

How do I search?

To search, use the arrow buttons to enter a few characters of the search term. With each additional character you enter, you narrow down the search and the search results become more relevant.

Tip: Use the free Roku mobile app on your smartphone or tablet to make searching even faster. Not only can you use your device's keypad to type, you can search simply by touching the voice search icon and saying the name of the movie, TV show, actor or director, channel, or game.

An icon next to each search result shows the category of the result (movie, TV show, actor).

- Press **RIGHT** to move the highlight into the list of search results.
- Press **UP** and **DOWN** to scroll through the list of search results to highlight the item you want to view.

I found a show, now what?

Now that you've highlighted the show, movie, actor, game, or streaming channel you were looking for, press **RIGHT**. If your search result was an actor, director, or other item that does not represent a single item of content, you'll see another list to narrow down your search. Continue highlighting results and pressing **RIGHT** until you find a single, viewable content item.

An **HD** logo means that the content is available in high-definition. The checked circle adjacent to the title means you have already added the streaming channels.

When you narrow down your search to a game or streaming channel, you'll see detailed information, images, and available actions such a list of streaming channels and the cost of getting the item on each channel.

The next time you use Roku Search, the **Search** screen displays a list of recent search selections in place of the search instructions.

Using the recent search selections list makes it easy to quickly get to a previously found item, for example, to find another movie with the same actor, or another TV show in the same series.

Using the Roku Channel Store

The **Streaming Channels** menu option takes you to the Roku Channel store, where you can add new streaming channels to your Roku TV.

Tip: The **Streaming Channels** menu option is available only if your TV is connected to the Internet.

Tip: You also can search for streaming channels by using the **Search** option, as explained in [“Searching for movies & shows”](#) on page 44.

To make it easier to find what you want, the streaming channels in the Roku Channel Store are categorized by topic. Press **UP** and **DOWN** to highlight the category you want, and then press **RIGHT** to move the highlight into the grid of streaming channel tiles.

When you find a streaming channel you want to add or learn more about, highlight it and press **OK** to display more details.

- If the streaming channel you are adding is free, you can select **Go to channel** to start watching it immediately.
- If there is a one-time or recurring fee associated with using the streaming channel, you must agree to the terms and conditions, accept the fee, and—if you created one when you activated your Roku TV, enter your Roku PIN code to authorize the charges.
- If you already have a subscription to the streaming channel—for example, you already subscribe to Netflix or you receive HBO through your cable TV provider—you must complete a different, simple authorization step to add the streaming channel.

You only have to complete the authorization or activation step one time, when you initially add the streaming channel. After that, you simply select the streaming channel tile from your **Home** screen to start watching. (Channel availability is subject to change.)

Tip: New streaming channels are added continuously, so be sure to check back every now and then.

Customizing your TCL• Roku TV

There are several things you can do to personalize your TCL• Roku TV.

Rearrange tiles

Whenever you add a TV input tile, it's added at the top of your **Home** screen. Whenever you add a new streaming channel from the Roku Channel Store, it's added at the bottom of your **Home** screen.

You can easily rearrange the order of the tiles on the **Home** screen to suit your viewing preferences. For example, you might want **Antenna TV** to be the first tile in your **Home** screen. But if you mostly watch one streaming channel, you might want its tile to be the first one on your **Home** screen.

Rearranging tiles is easy:

1. From the **Home** screen, highlight one of the tiles you want to move.
2. Press ***** to display a list of options for the type of tile you selected.
3. Select **Move input**. The list of options disappears and the highlighted tile shows arrows indicating how it can be moved

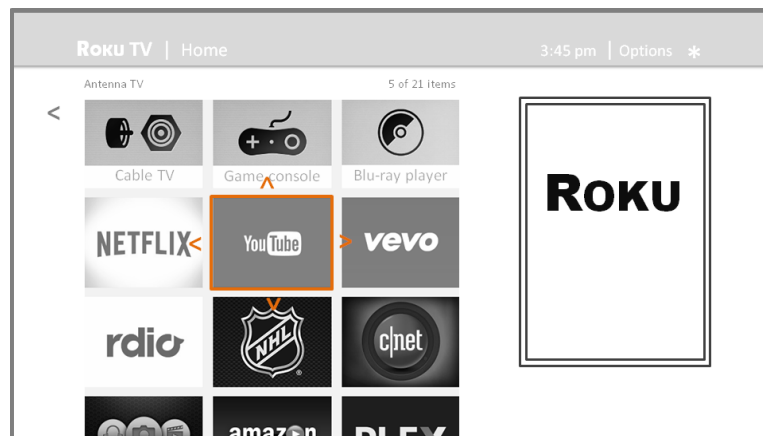

4. Use the arrow buttons to move the highlighted tile to its new position. As you move the tile, it pushes other tiles out of its way.
5. Press **OK** to lock the tile into its new position.

- Repeat these steps to move other tiles until you have arranged your **Home** screen to your liking.

Edit broadcast TV channel lineup

When you set up the TV tuner as described in “[Setting up Antenna TV](#)” on page 26, the TV adds all the channels with good signals that it could detect in your area. It’s likely that you now have more channels than you want in your channel list.

To edit the channel lineup, from the **Home** screen, navigate to **Settings > TV inputs > Antenna TV > Edit channel lineup**. You’ll see a screen listing all of your channels. Adjacent to the list of channels is a miniature TV screen playing the highlighted channel’s picture and sound.

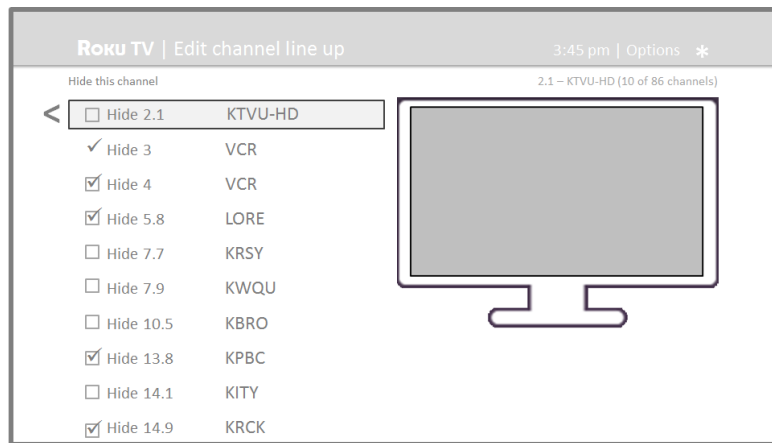

Highlight each channel you want to hide, and then press **OK** to hide the channel.

Tip: *If you need to see or hear the highlighted channel, wait a couple of seconds for the TV to start playing the channel’s picture and sound. Also note that if you’ve enabled parental controls and the program on the current channel is blocked, you won’t see a picture or hear sound while editing the channel lineup.*

Rename inputs

Rather than trying to remember that your Blu-ray player is connected to HDMI 1 and your game console is connected to HDMI 3, you can rename the TV inputs to match the connected component.

Note: *Renaming an input also changes the icon associated with it.*

To rename an input, you can either:

- Highlight the input tile in the **Home** screen, and then press ***** to display a list of options. From the list of options, select **Rename input**. Then select a new name and icon.

or

- From the **Home** screen, navigate to **Settings > TV inputs**. On the **TV inputs** screen, select the input you want to rename, select **Rename**, and then choose a new name and icon from the provided list.

Press  to return to the **Home** screen. The new name and icon are now in effect.

Remove unwanted tiles

It's easy to remove unused TV inputs and unwanted channel or app tiles. For example, if you never use the HDMI 3 input, or if you don't like the weather app you added from the Roku Channel Store, you can remove them from your **Home** screen.

You also can remove the **Antenna TV** tile if you never use the TV tuner. But be aware that removing the Antenna TV tile also deletes the broadcast TV channel list. You'll have to set up the TV tuner again next time you add it. Instructions for setting up the TV tuner can be found in "[Setting up Antenna TV](#)" on page [26](#).

- To remove any tile, highlight the input tile in the **Home** screen, and then press ***** to display a list of options. From the list of options, select **Remove input**. In the screen that follows, confirm you want to remove the input.
- Alternatively, to remove a TV input tile from the **Home** screen, navigate to **Settings > TV inputs**. On the **TV inputs** screen, select the input you want to remove, and then select **Remove > Confirm**. Then press  to return to the **Home** screen.

Change themes

Another way to customize your Roku TV is to change its theme. The theme establishes the look and feel of the TV through colors, designs, and fonts.

Tip: *Themes are available only when your TV is connected to the Internet.*

To change the theme, in the **Home** screen menu navigate to **Settings > Themes**. In the **Themes** screen, choose from the following options:

- **My themes** – Highlight a theme, and then press **OK** to switch to that theme.

- **Custom settings** – Turn **Featured themes** on or off. When **Featured themes** is on, the TV automatically switches to featured themes—like certain holidays—for a limited time whenever Roku makes them available, and then switches back to your selected theme when the featured theme expires. When off, the TV always uses your selected theme.

Change sound effects volume

Sound effects are the noises the TV makes to let you know it received your command. You can change the volume of sound effects or turn them off.

To adjust the sound effects volume, in the **Home** screen menu, navigate to **Audio > Menu volume**. Navigate to the right and then change the setting to **High, Medium, Low, or Off**.

Configure power settings

Power settings let you set up your TV so that it turns on to the location you choose. Power settings also help your TV save energy by automatically turning it off under certain conditions.

Power on settings

Power on settings tells the TV what to do when you turn on the power. To configure the power on settings, from the Home screen menu, navigate to **Settings > System > Power > Power on**. Highlight the power on location from the list, and then press **OK** to select it.

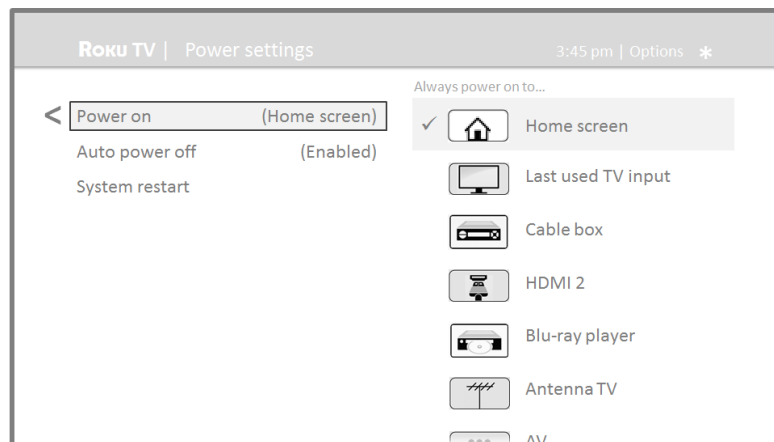

Auto power off settings

To help you save energy, your Roku TV can automatically turn itself off after a period of inactivity or a period during which no signal has been detected. It is factory-configured to do both of these things, but you can change these settings if needed.

To configure automatic power off, from the **Home** screen menu navigate to **Settings > System > Power > Auto power off**. In the **Power settings** screen, highlight the following options and press **OK** to turn them on or off:

- **After 15 minutes of no signal** – If no signal is detected on a TV input for 15 minutes, the TV automatically powers off.
- **After 4 hours of no interaction** – If no remote control or panel button is pressed for 4 hours and the TV is not displaying a TV signal or streaming a video, the TV is automatically powered off.

Configure parental controls

Parental controls enable you to control whether the members of your household can view certain kinds of broadcast TV programs. When a program or feature is blocked, you can unblock it by entering a parental control PIN that only you know.

Note: *The parental control feature can be used to hide the **Movie Store**, **TV Store**, and **News** options that are available on the **Home** screen menu of Roku TVs manufactured for the United States. However, the parental controls feature does not block other streaming content nor content from inputs other than the TV tuner.*

Creating a parental control PIN

The first time you access the **Parental controls** screen, you must create a new parental control PIN. Thereafter, whenever you want to change parental control settings, unblock programming that has been blocked, change the PIN, or disable parental controls, you must enter your parental control PIN.

Tip: *Your parental control PIN has nothing to do with your Roku PIN. You can make them the same if you want—this is entirely your choice.*

To create a new parental control PIN, from the **Home** screen menu navigate to **Settings > Parental controls**. The screen displays a numeric keypad. Use the arrow buttons and the **OK** button to enter a four digit code. Then repeat the process to enter the same PIN again, just to make sure you correctly entered the PIN you want to use.

Important: *If you forget your PIN, the only way to recover is to perform a factory reset operation, as explained in “[Factory reset everything](#)” on page 65. Be sure to write it down in a safe place just in case.*

Blocking Movie Store, TV Store, and News (US TV models only)

One of the parental control options is to completely hide the entertainment options that are available directly on the **Home** screen menu of Roku TVs manufactured for sale in the United States. (The Movie Store, TV Store, and News options are not available on Roku TVs manufactured for sale in Canada).

To hide **Home** screen entertainment options:

1. From the **Home** screen menu, navigate to **Settings > Parental controls**, and then enter your PIN.
2. In the **Parental controls** screen, highlight **Home screen** and then select or clear either of these options:
 - **Hide “Movie Store and TV Store”** – Removes the **Movie Store** and **TV Store** options from the **Home** screen menu.
 - **Hide “News”** – Removes the **News** option from the **Home** screen menu.

Tip: *To use either of these options after you’ve hidden them, you must return to this screen and remove the check mark from the corresponding **Hide** command.*

Blocking Broadcast TV shows

For broadcast TV, parental controls use information embedded in the broadcast signal to determine whether to allow a program to be displayed. Parents can configure parental controls to block broadcast TV programs that meet or exceed a specific rating, so they cannot be viewed or heard unless the correct parental control PIN is entered.

Enabling parental control of TV shows

The first step in blocking TV shows is to enable parental control of TV shows.

This setting is provided separately to make it easier for you to turn parental control of TV shows on and off without disturbing their settings. For example, your kids are going to summer camp for two weeks, and while they are gone, you don’t want to have to deal with unblocking shows that you want to watch by entering your PIN. All you need to do is clear **Enable parental controls**, and all TV shows are unblocked. When the kids return, select **Enable parental controls** again, and all of your parental control settings are restored in a single operation.

To enable parental control of TV shows:

1. In the **Home** screen menu, navigate to **Settings > Parental controls**, and then enter your PIN.
2. In the **Parental controls** screen, navigate to **TV tuner > Parental control of TV shows**.

3. Make sure the check box next to **Enable parental controls** is checked. If not, highlight it and press **OK**.

Blocking based on US TV ratings

Most broadcast US TV shows—other than movies—contain rating data that enables parental controls to block shows that parents don't want others to view. The ratings are divided into two groups that function independently:

- **Youth group** – TV-Y, TV-Y7
- **Main group** – TV-G, TV-PG, TV-14, TV-MA

Within each of these groups, the ratings interact such that if you block a particular level of content, the TV also blocks all content with a higher rating. Conversely, if you unblock a particular level of content, the TV also unblocks all content with a lower rating. For example, if you block TV-PG programs, the TV also blocks TV-14 and TV-MA programs. If you subsequently unblock TV-14 programs, TV-PG programs are also unblocked, but TV-MA programs remain blocked.

Similarly, within the main group, content types can be individually blocked. For example, you can block just coarse language in shows with a TV-PG rating. If you do, then the TV also blocks shows with coarse language in the higher ratings (TV-14 and TV-MA). Subsequently unblocking coarse language in TV-14 ratings does not unblock coarse language in TV-MA programs, but it does unblock coarse language in TV-PG programs.

To block TV shows based on US television ratings:

1. From the **Home** screen menu, navigate to **Settings > Parental controls**, and then enter your PIN.
2. In the **Parental controls** screen, navigate to **TV tuner > TV ratings**. Choose among the following settings:
 - **Entire ratings** – Highlight the rating you want to block, and then navigate to the right and select the first option that blocks the entire rating level (and all higher rating levels).
 - **Individual content types** – Highlight the rating that contains the content type you want to block, and then select the content types you want to block from among those listed. Remember that blocking a content type in one rating blocks the equivalent content type in all higher rating levels.

Blocking based on US movie ratings

Most movies in the US are rated by the Motion Picture Association of America, or MPAA, so the ratings are known as MPAA ratings. TV broadcast signals carry movie rating data that enables parental controls to block shows that parents don't want others to see. The ratings are:

- G – General audiences
- PG – Parental guidance suggested
- PG-13 – Parents strongly cautioned for children age 13 or younger

- R – Restricted
- NC-17 – Not for age 17 or younger

Unlike US TV ratings, there are no individual content types within the ratings. But like TV ratings, blocking movies with a particular rating also blocks movies with a higher rating, and unblocking movies with a particular rating also unblocks movies with a lower rating.

Tip: *Blocking movies with an NC-17 rating also blocks programs with the now-obsolete X rating, which can still occur in the program data of older movies.*

To block movies based on MPAA ratings:

1. From the **Home** screen menu, navigate to **Settings > Parental controls**, and then enter your PIN.
2. In the **Parental controls** screen, navigate to **TV Tuner > Movie ratings**.
3. Select the rating level you want to block. You need only select one rating level, and all higher levels are automatically blocked.

Blocking based on Other ratings

Your Roku TV can block programs having ratings that had not been defined when the TV was manufactured. It does this by detecting a new Rating Region Table in a program and then downloading the new table and displaying its rating in the Parental controls.

When the TV downloads a new Rating Region Table, it adds a new option to the list of rating types: **Other ratings**. If you see this option in the **Parental controls** screen, you have tuned to a station that has implemented a new rating table. Once the new rating table has been downloaded to the TV, it remains in the TV until it is factory reset, and you can configure blocking based on the new ratings.

New Region Rating Tables can have independent rating levels, or rating levels that interact in the same ways as the built-in US TV and MPAA Movie ratings.

Tip: *If your TV downloads a new Region Rating Table, you'll have to experiment with its settings to understand how to use it.*

Blocking based on Canadian English ratings

Canadian-English language and third-language programs that are broadcast in Canada are rated by the Action Group on Violence on Television, or AGVOT. TV broadcast signals carry rating data that enables parental controls to block shows that parents don't want others to view based on content containing violence, language, sex, or nudity. The ratings are:

- C – Children under 8 years
- C8 – Children 8 years and older
- G – Generally suitable for all age groups
- PG – Parental guidance suggested for viewers under 14 years
- 14+ – Generally not suitable for viewers under 14 years

- 18+ – Generally not suitable for viewers under 18 years

Blocking content with a particular rating also blocks content with a higher rating, and unblocking content with a particular rating also unblocks movies with a lower rating.

To block programs based on AGVOT ratings:

1. From the **Home** screen menu, navigate to **Settings > Parental controls**, and then enter your PIN.
2. In the **Parental controls** screen, navigate to **TV tuner > Canadian English ratings**.
3. Select the rating level you want to block. You need only select one rating level, and all higher levels are automatically blocked.

Blocking based on Canadian French ratings

Canadian-French language programs that are broadcast in Canada are rated by the Régie du cinéma du Québec. TV broadcast signals carry rating data that enables parental controls to block shows that parents don't want others to view based on content containing violence, language, sex, or nudity. The ratings are:

- G – Generally suitable for all age groups
- 8+ – Viewers 8 years and older
- 13+ – Viewers 13 years and older
- 16+ – Viewers 16 years and older
- 18+ – Adults only

Blocking content with a particular rating also blocks content with a higher rating, and unblocking content with a particular rating also unblocks movies with a lower rating.

To block programs based on Canadian-French ratings:

1. From the **Home** screen menu, navigate to **Settings > Parental controls**, and then enter your PIN.
2. In the **Parental controls** screen, navigate to **TV tuner > Canadian French ratings**.
3. Select the rating level you want to block. You need only select one rating level, and all higher levels are automatically blocked.

Blocking unrated programs

Some broadcast TV shows and movies are assigned a rating of "Unrated". Whether or not such programs contain content that is objectionable to you cannot be determined. However, you can choose to block such programs.

To block all unrated broadcasts:

1. From the **Home** screen menu, navigate to **Settings > Parental controls**, and then enter your PIN.
2. In the **Parental controls** screen, navigate to **TV tuner > Block all unrated programs**.

3. Highlight **Block** and press **OK**. When blocking is enabled, the adjacent padlock icon changes from unlocked to locked.

Tip: *Blocking programs that have been assigned a rating of “Unrated” does not block programs that have no rating assigned to them (for example a broadcast of a local town council meeting). Programs that do not have an assigned rating display **Rating NA** (for “not applicable, meaning a rating is not needed). Programs that have no assigned rating are considered “safe”; therefore, there is no need to block them.*

What happens when a TV show is blocked?

After you’ve set up parental controls, TV shows and movies can be blocked:

- When you change channels and the new channel is playing a program whose rating exceeds your settings.
- When a new show comes on the channel you are watching and its rating exceeds your settings.

When a program is blocked by parental control settings, the TV displays a blocked message:

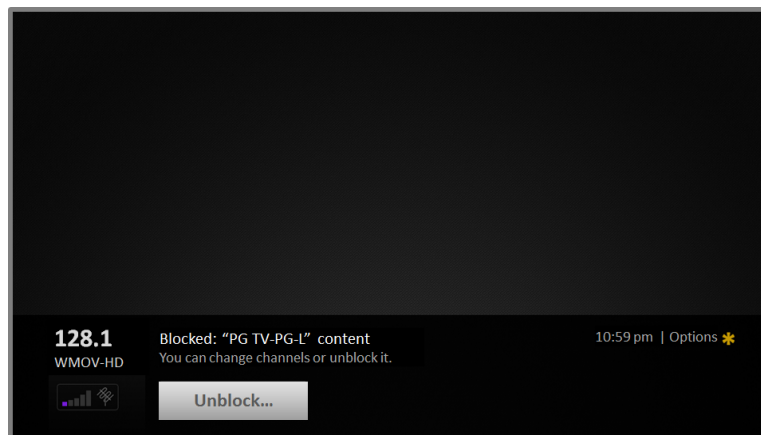

Whenever this blocked message appears, both the video and audio of the show are blocked, as well as program data that would normally appear in the area at the bottom of the screen.

To watch the blocked program, you need to know the PIN code defined when you enabled parental controls, as explained in [“Creating a parental control PIN”](#) on page 51.

1. Press **OK** to select **Unblock** and display a PIN pad.

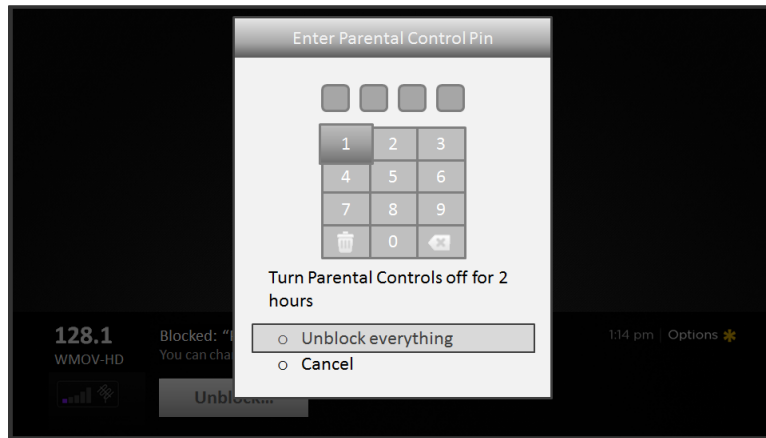

2. Use the arrow buttons to enter your PIN code, and then press **OK** to select **Unlock everything**.

After unblocking shows that have been blocked, all blocking is disabled for two hours or until you turn off the TV.

Changing the parental control PIN

To change your parental control PIN:

1. From the **Home** screen menu, navigate to **Settings > Parental controls**, and then enter your PIN.
2. In the **Parental controls** screen, highlight **Change PIN**.
3. Move the highlight into the adjacent keypad, and then use the arrow buttons and the **OK** button to enter a four digit code. Then repeat the process to enter the same PIN again, just to make sure you correctly entered the PIN you want to use.

Resetting parental controls

So now your kids have grown up and gone away to college, and you no longer want to deal with blocked programs.

To erase all parental control settings:

1. From the **Home** screen menu, navigate to **Settings > Parental controls**, and then enter your PIN.
2. In the **Parental controls** screen, highlight **Reset parental controls**.
3. Follow the instructions on the screen to confirm that you want to erase all parental control settings.

Tip: *Resetting parental controls also erases your parental control PIN.*

More settings

This section describes the features and settings of the Roku TV that were not covered in the other parts of this guide.

Changing network settings

If needed, you can change your network settings at any time. For example, if you change the name of your wireless network (its SSID) or its password, you will need to change your TV's settings so that it can continue to connect. Also, if you decided not to connect to the Internet in "[Guided Setup](#)" on page [12](#), you can use Network settings to connect at a later time.

To change network settings, from the **Home** screen menu, navigate to **Settings > Network**, and then press **RIGHT**. At this point, you can choose the following options:

- **Update connection** – Press **OK** to start the update process. The TV uses your current wireless network name and password to reconfirm the wireless connection, the local network connection, and the Internet connection.
- **Set up new Wi-Fi connection** – Press **OK** to start a scan for wireless networks. The TV scans for the wireless networks within range and displays the first few it finds in order, with the strongest signals first. In addition to your own wireless signal, the TV might pick up signals from your neighbors. Now you can do one of the following:
 - **Select your network name** – Select the name of your network and then enter your wireless password if requested.
 - **Scan again** – If you don't see your wireless network name in the list, select **Scan again** to list all networks in range. The first scan listed only the first few, strongest wireless signals. The second scan sometimes results in a longer list. If you still don't see your network name, you might need to adjust the location of the wireless router or the TV, turn on your router, or make other changes. When everything is ready, select **Scan again** to repeat the network scan.

Note: *Highlighting **Scan Again** displays an informational panel with the unique media access control (MAC) address of your Roku TV. You will need the MAC address if your wireless router is configured to use MAC address filtering.*

- **Private network** – If your wireless network name is hidden, it won't appear in the list. Select **Private network** to display an on-screen keyboard, and use it to enter your

network name. Unless you changed the factory-set network name, you can find the name (also called SSID) on a label the router.

Tip: *Wireless networks that are password-protected display a “padlock” icon adjacent to the name.*



Changing caption settings

You can change many different settings that affect the appearance of captions.

To change caption settings, from the **Home** screen menu, navigate to **Settings > Captions**, and then press **RIGHT**. At this point, you can choose the following options:

- **Captions mode** – Choose **Off**, **On**, **When mute**, or **Instant replay**.
 - If you choose **On**, the TV displays captions whenever they are available in the program information. *This setting applies to Antenna TV, the AV input, and streaming channels.*
 - If you choose **When mute**, the TV displays captions only when the sound is muted. *This setting applies to Antenna TV, the AV input, and streaming channels.*
 - If you choose **Instant Replay**, the TV displays captions only during a replay operation; that is, after pressing ↶ to jump back a few seconds in streaming video. *This setting applies only to streaming channels when the program being streamed supports instant replay.*

Note: *If ↶ is not available on your remote control, you can use ↶ on the Roku App or the Jump Back button on a universal remote. For more information, see “[Other devices](#)” on page [69](#).*

This setting reflects the **Closed captioning** settings in the **Options** menu for certain TV inputs, as explained in “[Options menu settings](#)” on page [39](#). *Note that, once enabled, the captions mode remains set for all applicable inputs until you turn it off.*

Tip: *Some streaming channels require you to enable captions through a setting within their channel even though you have turned on captions everywhere else.*

- **Text style** – Choose from a list of fonts. As you move the highlight to each font, you can see a sample of the result in an adjacent panel.
- **Text edge effect** – Choose from a list of edge effect styles, such as raised, depressed, and various shadows. As you move the highlight to each effect, you can see a sample of the result in an adjacent panel.
- **Text size** – Choose from a list of sizes. As you move the highlight to each size, you can see a sample of the result in an adjacent panel.

- **Text color** - Choose from a list of colors for the text. As you move the highlight to each color, you can see a sample of the result in an adjacent panel.
- **Text opacity** - Choose from a list of opacity settings for the text. This setting determines how much the area behind the text shows through the text. A value of 100% blocks all of the content behind the text. As you move the highlight to each setting, you can see a sample of the result in an adjacent panel.
- **Background color** - Choose from a list of colors for the background area behind the text. As you move the highlight to each color, you can see a sample of the result in an adjacent panel. Note that you won't see any change unless you set the **Background opacity** to a value other than **Off**.
- **Background opacity** - Choose from a list of opacity settings for the background of the caption. This setting determines how much the area behind the caption background shows through the background. A value of 100% blocks all of the content behind the background. As you move the highlight to each setting, you can see a sample of the result in an adjacent panel.
- **Window color** - Choose from a list of colors for the window rectangle surrounding the entire caption. As you move the highlight to each color, you can see a sample of the result in an adjacent panel. Note that you won't see any change unless you set the **Window opacity** to a value other than **Default** or **Off**.
- **Window opacity** - Choose from a list of opacity settings for the window rectangle surrounding the entire caption. This setting determines how much the area behind the caption window shows through the window. A value of 100% blocks all of the content behind the window. As you move the highlight to each setting, you can see a sample of the result in an adjacent panel.

Changing time settings

You can change time settings to suit your preferences. You can find the following settings by navigating from the **Home** screen menu to **Settings > Time**:

- **Sleep timer** – Set a time delay after which the TV will automatically shut off. This setting reflects the setting you can make in the **Options** menu from any TV input, as explained in “[Options menu settings](#)” on page [39](#). *Note that the sleep timer setting is not input specific.*
- **Time zone** – Select whether to set the time zone automatically or manually, and if set manually, select your current time zone. Typically, a TV connected to the Internet can discover its own time zone automatically, and a TV that is not connected to the Internet must be set manually. Initially, this setting is made when you set up the TV tuner, as explained in “[Setting up Antenna TV](#)” on page [26](#). Correct time zone information is needed to correctly display program data.
- **Clock format** – Select whether to display time in a 12-hour or 24-hour format, or to turn off time display. *This setting is available only on TVs that are connected to the Internet. Non-connected TVs do not display time.*

Scanning for broadcast TV channels again

There will be times when you need to create a new channel list. For example, you:

- Change cable providers
- Reorient your TV antenna
- Move to a different city with different channels

Whenever you need to update your TV channel list, you can repeat the channel scan.

Tip: Repeat the channel scan from time to time to make sure you are receiving all of the latest channels. Broadcasters add and remove channels, move channels to different parts of the spectrum, and change the power levels of their channels periodically.

To repeat the channel scan, from the **Home** screen menu, navigate to **Settings > TV inputs > Antenna TV > Scan again for channels**. Then select **Start finding channels** to begin the channel scan process. The screens and options that appear during this process are identical to those described in [“How do I set up the TV tuner?”](#) on page 26.

Using the TCL• Roku TV in a home theater

Your Roku TV has several features that make it an ideal TV for a home theater. But you might not notice them because they remain in the background until you decide to use them.

Turning off TCL• Roku TV speakers

When you use your TV with a sound bar or an external amplifier and speakers, you'll probably want to turn off the internal TV speakers.

To turn off the TV's built-in speakers, in the **Home** screen menu, navigate to **Settings > Audio > TV speakers** and change the setting.

Tip: The TV's internal speakers can be enabled and disabled automatically as needed by system audio control, as described in [“Enabling system audio control”](#) on page 64. [The internal speakers are also turned off when you use the headphone jack](#)

Changing the audio mode

The TV has two audio modes, accessed by navigating in the **Home** screen menu to **Settings > Audio > Audio mode**:

- **Stereo** – Use this setting for internal speakers, headphones, and external stereo amplifiers connected through HDMI[®] ARC, SPDIF optical, or headphone jack.
- **Auto** – Use this setting to automatically detect the best audio setting based on the audio stream in the content you are watching. If you have connected the TV to an external Dolby Digital or Dolby Digital Plus compatible amplifier, receiver, or sound bar through HDMI[®] ARC or SPDIF optical, the TV automatically selects the appropriate surround sound capabilities of the device based on the characteristics of the current program.

Setting up a digital audio connection

You can connect the TV to an external amplifier, receiver, or sound bar by using either of these two connections:

- **HDMI ARC** – The HDMI[®] Audio Return Channel enables the TV to output digital audio on one of its HDMI[®] connectors. The connected amplifier can also function simultaneously as an input source to the TV, if needed. To use the ARC capability, you must connect an HDMI[®] cable from your amplifier's HDMI[®] ARC connector to the HDMI ARC connector on the TV. You also must:
 - Be sure your HDMI[®] cable is certified by HDMI[®].
 - Select the appropriate setting under **Settings > Audio > Audio mode**, as explained in [“Changing the audio mode”](#) on page 62.
 - Enable **HDMI ARC** under **Settings > System > CEC**, as explained in [“Enabling HDMI[®] ARC”](#) on page 63.
- **SPDIF optical** – The TV has an SPDIF optical connector that outputs a digital audio signal. To use the optical output, connect a TOSLINK optical cable from the amplifier to the Optical or SPDIF connector on the TV. You also must:
 - Select the appropriate setting under **Settings > Audio > Audio mode**, as explained in [“Changing the audio mode”](#) on page 62.
- **Note:** *Dolby Digital Plus format is only output through the HDMI[®] ARC connection.*

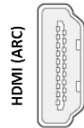

After making the required HDMI[®] ARC or SPDIF optical connection, go to **Settings > Audio > S/PDIF and ARC** option and select the audio format to use.

Note: In most cases, **Auto detect** is the best option. Other settings can result in no sound when the content you are viewing does not contain the audio stream type you selected.

Controlling other devices through CEC

Consumer Electronics Control (CEC) enables your Roku TV and other CEC-compatible home entertainment components to control one another in various ways. First, the CEC-compatible devices must “discover” one another and report their capabilities. After this, one device can control another according to the features you enable. For example, playing a disc on a Blu-ray player could switch the TV to the Blu-ray player’s input. Or, powering off the TV could also power off the Blu-ray player and the home theater receiver.

Discovering connected CEC devices

To discover CEC devices:

1. Make sure that your CEC-compatible components are connected to the TV with a suitable high-speed HDMI[®] cable that supports HDMI[®] ARC and CEC control.
2. Turn on each component and make sure all components have CEC enabled.

Tip: Some manufacturers have their own branded names for CEC functionality, so you might need to read the product documentation to correctly identify the CEC features of the device.

3. On the TV’s **Home** screen menu, navigate to **Settings > Control other devices (CEC) > Search for CEC devices**, and then press **OK** to start the discovery process.

When finished, the TV displays a list of CEC devices that are connected to each HDMI[®] input, as well as any devices that had previously been connected. The TV remembers the names of multiple CEC devices even when they are no longer connected. If the list is longer than the allowed space, press ***** to see a complete list in a scrollable window.

Enabling HDMI[®] ARC

HDMI[®] ARC is the audio return channel that is available on one of the TV’s HDMI[®] ports. The audio return channel enables you to send a Dolby Digital audio signal back to a home theater receiver that is also sending an audio and video signal into the TV. Using HDMI[®] ARC reduces the number of cables needed and optionally lets you control the volume and mute state of the receiver by enabling system audio control.

HDMI[®] ARC is disabled by default. To enable HDMI[®] ARC, in the **Home** screen menu, navigate to **Settings > System > Control other devices (CEC)**, and then highlight **HDMI ARC**. Press **OK** to check the adjacent check box.

Enabling system audio control

System audio control enables the TV remote control to change the volume and mute state of an amplifier or sound bar connected through HDMI[®], and to display the external device's volume and mute status in the TV's on-screen display.

The TV automatically turns off its internal speakers and sends volume and mute control signals to an external amplifier when all of the following are true:

- System audio control is enabled on the TV.
- A CEC-compatible amplifier is powered on and CEC discoverability is enabled.
- The CEC-compatible amplifier's HDMI[®] ARC connector is connected to the TV's HDMI ARC connector with a suitable HDMI[®] cable.

When the CEC-compatible amplifier is off, the TV automatically turns on its speakers (unless you have turned them off as described in "[Turning off TCL• Roku TV speakers](#)" on page [61](#)) and resumes local control of volume and mute state.

System audio control is disabled by default. To enable system audio control, in the **Home** screen menu, navigate to **Settings > Control other devices (CEC)** and highlight **System audio control**. Press **OK** to check the adjacent check box.

Enabling 1-touch play

1-touch play enables a component to control which TV input is active. For example, pressing **Play** on your Blu-ray player switches the TV to the Blu-ray input.

1-touch play is disabled by default. To enable 1-touch play, in the **Home** screen menu, navigate to **Settings > Control other devices (CEC)** and highlight **1-touch play**. Press **OK** to check the adjacent check box.

Enabling system standby

The system standby feature causes other components to power off when you power off your TV. Depending on the CEC System Standby implementation, it also might enable connected components to power off your TV when you power off the component.

System standby is disabled by default. To enable system standby, in the **Home** screen menu, navigate to **Settings > Control other devices (CEC)** and highlight **System standby**. Press **OK** to check the adjacent check box.

Restarting the TCL• Roku TV

You can restart the TV when necessary. Restarting has the same effect as unplugging the TV power and then plugging it in again.

To restart the TV, navigate to **Settings > System > Power** and then move right to **System restart** and then **Restart**. Press **OK** to confirm restart.

While the TV restarts, the screen goes dark for a few seconds, and then displays the startup screen for a few more seconds. When the restart operation is complete, you'll see the familiar **Home** screen.

Resetting the TCL• Roku TV

You can choose to reset only the TV picture and audio settings to their original values, or perform a full factory reset to return the TV to the state it was in when you first unpacked and turned it on.

Reset TCL• Roku TV settings

To reset only the TV picture and audio settings to their original values, navigate to **Settings > System > Factory Reset**, and then highlight **Reset TV settings**. Read the information on the screen to make sure you understand what the reset operation does.

To proceed with the reset operation, press **PLAY/PAUSE** three times in a row.

Factory reset everything

A full factory reset returns the TV to its original, out-of-the-box state. When finished, you must repeat Guided Setup, reconnecting to the Internet, re-linking your Roku account, and reloading any streaming channels. You also must repeat Antenna TV setup and input configuration.

Factory reset is the recommended choice if you want to transfer the TV to another owner, and is the only choice if you want to switch from store mode to home mode (if you inadvertently selected store mode during Guided Setup).

To perform a factory reset, navigate to **Settings > System > Factory reset**, and then highlight **Factory reset everything**. Read the information on the screen to make sure you understand what this reset operation does.

To proceed with the full factory reset, press **PLAY/PAUSE** three times in a row.

What if I can't access the Factory Reset option?

It is possible that your TV might get into a state where you cannot access the various menus, including the menu option that lets you perform a factory reset operation. If that happens, you can force the TV to reset by following these steps:

1. Using a straightened paper clip or ball-point pen, press and hold the recessed RESET button on the TV connector panel.
2. Continue to hold the RESET button for approximately 12 seconds.

During this time, the status light turns off, and then turns on bright, and then pulses. When the reset cycle completes, the light either comes on dim (if the TV power was off when you started) or the TV screen comes on and the light turns off (if the TV power was on when you started).

3. When the status light turns on steady dim or the TV screen comes on, release the RESET button.
4. Proceed through Guided Setup. See “

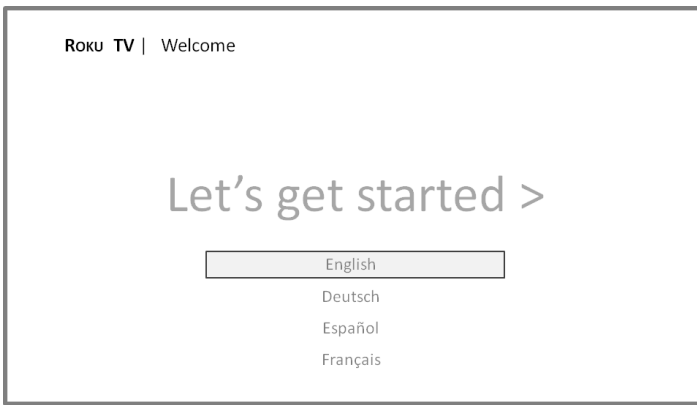

5. [Setting up your TCL• Roku TV™](#) on page [13](#).

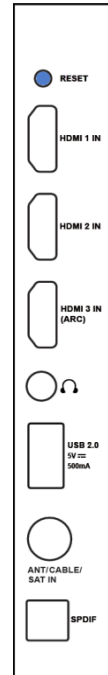
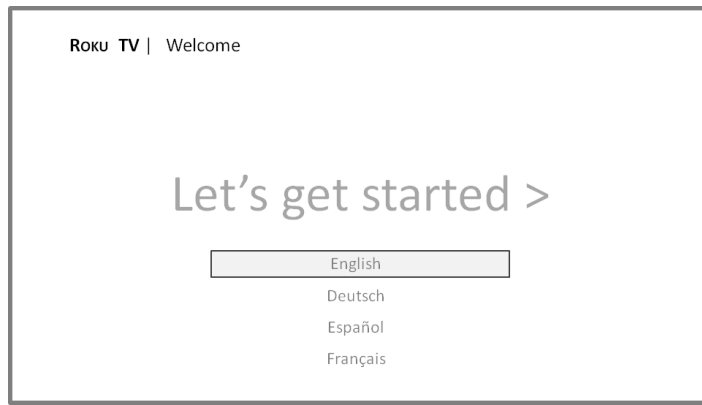

Getting system updates

If your TV is connected to the Internet and linked with a Roku account, it will automatically get updates from time to time. You don't need to do anything. But if you are aware that an update is available and you don't want to wait until the TV updates itself, you can manually check for updates.

If your TV is not connected to the Internet, you can still get updates by using a USB flash drive.

You can download an updated User Guide that matches your Roku TV software version from the TCLweb site at:

www.TCLUSA.com/support

To determine your current Roku TV software version, go to **Settings > System > About** after you complete Guided Setup.

Checking for updates on a connected TCL• Roku TV

If you're one of those people who has to have the latest, most up-to-date gadgets the moment they are available, you can check for updates as often as you want.

To check for updates, navigate to **Settings > System > System update**, and then select **Check now**. The TV responds either with a message saying that your TV is up to date, or with a message saying that an update is available.

Follow the instructions on the screen to install the system update.

Getting updates on a non-connected TCL• Roku TV

If your TV is not connected to the Internet, you can still get system updates by using a USB flash drive and a computer with an Internet connection.

To get a system update, navigate to **Settings > System > System update**:

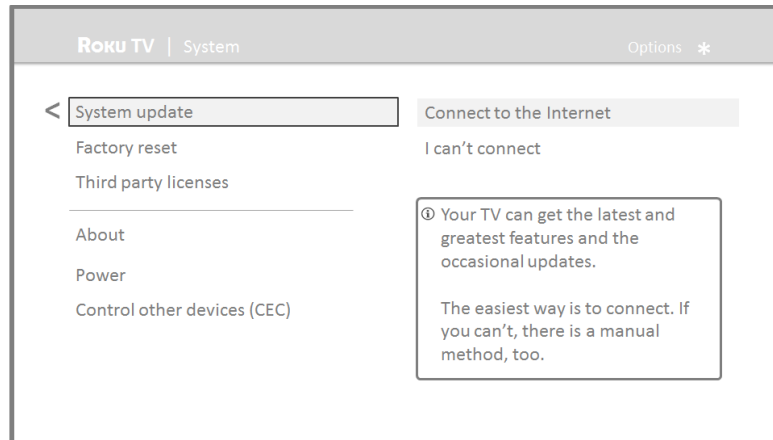

The **System update** screen on a non-connected TV gives you the opportunity to connect your TV to the Internet to automatically receive updates. We recommend this option if it is possible in your situation. To proceed, select **Connect to the Internet** and follow the instructions in [“But what if I didn’t connect my TCL• Roku TV?”](#) on page 24.

Otherwise, if you can’t connect to the Internet, select **I can’t connect**, and then follow the instructions on the screen. Here’s a summary:

1. On an Internet-connected computer, go to the web site displayed on the **System update** screen.
2. On the **USB Update** web page, select the correct TCL• Roku TV model and then click **Download**. Save the file to the root folder of a standard USB flash drive.
3. When the download finishes, take the USB flash drive to the TV and plug it into the USB port. When you do, the TV validates the files on the flash drive and displays a 12-digit code.
4. Write down the code and the web address, and take this information back to your Internet-connected computer.
5. On the **12-digit code** page, enter the code your TV displayed, and then click **Next**.
6. On the **6-digit code** page, write down the 6-digit code that appears, and then take it back to your TV.
7. Using the TV remote control, select **Next** to move to the next screen, and then use the on-screen keyboard to enter the 6-digit code. When finished, select **OK**. The system update begins. Do not remove the USB flash drive until the TV restarts.

USB flash drive

Any normal USB flash drive will work, provided it has a FAT-16 or FAT-32 file system format. (This is the default for most flash drives.)

The size of the download is small—usually less than 100 MB—and so will fit on any size flash drive you might have.

12- and 6-digit codes

The USB update process uses a pair of codes to validate that you are authorized to install an update, and to ensure you are not attempting to install an old, unsupported version of the system software.

When the update finishes, the TV restarts. You can check the new version number by navigating to **Settings > System > About**.

Other devices

Screen Mirroring your phone or tablet

Your Roku TV has a feature called screen mirroring that lets you mirror your smartphone or tablet on your TV. Share videos, photos, web pages, and more from compatible devices*. This screen mirroring feature is in a 'beta' period, which lets you try it out and allows Roku to learn what needs to be improved—so don't be surprised if it doesn't work perfectly.

For information on which devices may work with Roku TV screen mirroring and instructions on how to use it, see <http://support.roku.com/entries/56266670-How-do-I-enable-screen-mirroring-on-my-Roku-player->.

Getting and using the Roku mobile app

Roku makes the Roku mobile app free for compatible iOS, Android, and Microsoft Windows 8/8.1 devices.

With the Roku mobile app, you can control your Roku TV, find and add new Roku Channels, search and find something to watch, and even use your voice to search without typing. More information can be found by going to support.roku.com/home and searching for "mobile app."

Using a universal remote

In many cases, you can program your cable or satellite universal remote control to also control your Roku TV. You will need to have instructions for programming the remote control handy. Check with your cable or satellite provider for instructions.

For details on how to set up the Roku TV to work with universal remote controls, visit www.roku.com/universalremote.

* Many features work with top mobile devices. Please see support.roku.com for compatibility information.

FAQ

For the latest answers to Frequently Asked Questions, visit Common Questions section of the TCLTV support website (www.TCLUSA.com/support) and the Support section of the Roku website (www.roku.com).

Other information

Battery Caution and Disposal Information

- For best results, use alkaline batteries.
- Install only new batteries of the same type in your product.
- Failure to insert batteries in the correct polarity, as indicated in the battery compartment, may shorten the life of the batteries or cause batteries to leak.
- Do not mix old and new batteries.
- Do not use Rechargeable (Nickel Cadmium) or (Nickel Metal Hydride) batteries.
- Do not mix Alkaline, Standard (Carbon-Zinc) or Rechargeable (Nickel Cadmium) or (Nickel Metal Hydride) batteries.
- Do not dispose of batteries in fire.
- Recycle or dispose of batteries as per state and local guidelines.

Electronics Recycling Information For Consumers

TCL strives to provide a high level of service to our customers and in the communities we serve, and recommends that consumers always look for a recycling or reuse alternative to throwing away televisions and other electronics. We encourage customers to recycle end-of-life electronic devices using one of the many convenient methods available today. In many states TCL has programs in place to enable consumers to drop-off and recycle televisions free of charge. For information on electronics recycling in all 50 states, including drop-off locations, please visit the “Electronics Recycling” area of the TCL USA website at www.tclusa.com.

Care and Cleaning

- **Caution:** Turn off your TV before cleaning.
- Clean the TV as needed using a soft lint-free cloth. Be sure to occasionally dust the ventilation slots in the cabinet to help assure adequate ventilation.
- **IMPORTANT:** Never use strong cleaning agents, such as ammonia-based cleaners, or abrasive powder. These types of cleaners will damage the TV. The TV’s screen may be cleaned with a soft, lint-free cloth as well. Take care not to scratch or mar the screen. If necessary, you may use a cloth dampened with warm water. While cleaning, do not spray liquid directly on the screen, or allow liquid to run down the screen and inside the TV. Also,

never place drinks or vases with water on top of the TV. This could increase the risk of fire, shock hazard or damage to the TV.

Television Specifications

- Broadcasting system US System NTSC-M, ATSC standard (8VSB), QAM
- Receiving Channels VHF2-13, UHF14-69, CATV 14-36 (A)-(W), 37-59 (AA)- (WW), 60-85 (AAA)-(ZZZ), 86-94 (86)-(94), 95-99 (A-5)-(A-1), 100-135(100)-(135), 01 (4A)
- Tuner type Frequency synthesized
- Operating Temperature 5°C to 35°C (41°F to 95°F)
- Operating Humidity 20% to 80%, non-condensing
- Storage Temperature -15°C to 45°C (5°F to 113°F)
- Storage Humidity 10% to 90%, non-condensing

Notices

TTE Technology, Inc. (“TTE”) Limited Warranty

All TCL LCD/LED Models

What your warranty covers: Defects in materials or workmanship to the **original owner** of this TCL product when purchased **as new from an Authorized Dealer** of TCL brand products in the United States and packaged with this warranty statement.

New LCD/LED Televisions (Non-Commercial Use)

For how long after your purchase:

- **One (1) year from date of purchase** for parts and labor for **non-commercial use**.

New LCD/LED Televisions (Commercial Use)

For how long after your purchase:

- **Six (6) months from date of purchase for parts and labor for commercial use.**
- Commercial use includes, but is not limited to, the use of this product in a commercial or business environment, the use of this product in an institution or for institutional purposes, or other commercial purposes including rental purposes.

What we will do

- At TTE’s discretion, (1) pay an Authorized TCL Service Center for both labor charges and parts to repair your television, or (2) replace your television with a new or refurbished/remanufactured equivalent value product. The decision to repair or replace will be made solely by TTE. See “How to get service”.

How to get service

- Please have your original purchase receipt or proof of purchase (bill of sale or receipted invoice) which states that condition of the unit (New, Used, etc.), the unit's date of purchase, place of purchase and model/serial number ready. The model/serial number information can be found on the back of your unit.
- Call 1-877-300-8837 or visit www.TCLUSA/SUPPORT
- A representative must troubleshoot your problem over the telephone or through e-mail before receiving service. If it is determined that your unit requires service, the service location will be at the sole discretion of TTE based upon the TTE Limited Warranty Statement.
- At the sole discretion of TTE, television screen sizes 40" and smaller will either be repaired at an Authorized TCL Service Center or directly exchanged for a new or refurbished/remanufactured unit. At the sole discretion of TTE, television screen sizes 40" through 55" or larger will either be repaired at an Authorized TCL Service Center or repaired in-home.
- If repaired at an Authorized TCL Service Center, TTE is not responsible for transportation costs to the Authorized TCL Service Center. However, TTE will pay for return shipping. TTE will provide instructions for packaging and shipping the unit. **Units that are improperly packed and damaged during shipping are not covered under your product warranty.**
- Proof of purchase in the form of a bill of sale or receipted invoice from an Authorized Dealer which is evidence that the product is within the warranty period must be presented to obtain warranty service.
- In the event that a unit is to be replaced, a picture of the back of the unit showing the model and serial number and picture of the issue itself may be required.
- PRE-AUTHORIZATION MUST BE OBTAINED BEFORE (1) SENDING ANY PRODUCT TO AN AUTHORIZED TCL SERVICE CENTER, OR (2) OBTAINING ANY IN-HOME REPAIR/REPLACEMENT/ RENTAL SERVICES.

What your warranty does not cover

- **A unit sold in "As-Is", "Used", "Factory Reconditioned", "Factory Re-Certified", or "Refurbished", condition or with faults.**
- Units physically broken during shipment from a Retailer. Please contact your Retailer for assistance.
- Extended Service Plans purchased from Retailers. Please contact your Retailer for assistance.
- Customer instruction. (Your Owner's Manual describes how to install, adjust, and operate your unit. Any additional information should be obtained from your Authorized Dealer).
- Installation and related adjustments, or damage resulting from installation.
- Damage resulting from non-approved installation methods.
- Signal reception problems not caused by your unit.
- Damage from misuse, abuse, neglect, normal wear and tear, cosmetic damage, mishandling, faulty installation, or power line surges.
- Markings or images on the television's panel resulting from viewing fixed images (including but not limited to certain 4:3 images on wide screen televisions, or data or images in fixed screen locations from banners, video games, or certain broadcast networks).
- Batteries.
- A television that has been modified or incorporated into other products.
- A unit purchased or serviced outside the USA.
- Acts of nature or God, such as but not limited to earthquake or lightning damage.
- Special, incidental or consequential damages.

LIMITATION OF WARRANTY

- THE WARRANTY STATED ABOVE IS THE ONLY WARRANTY APPLICABLE TO THIS PRODUCT. NO VERBAL OR WRITTEN INFORMATION GIVEN BY TTE TECHNOLOGY, INC., ITS AGENTS OR EMPLOYEES SHALL CREATE A GUARANTY OR IN ANY WAY INCREASE OR MODIFY THE SCOPE OF THIS WARRANTY.
- REPAIR OR REPLACEMENT AS PROVIDED UNDER THIS WARRANTY IS THE EXCLUSIVE REMEDY OF THE CONSUMER. TTE TECHNOLOGY, INC. SHALL NOT BE LIABLE FOR SPECIAL, INCIDENTAL, OR CONSEQUENTIAL DAMAGES RESULTING FROM THE USE OF THIS PRODUCT OR ARISING OUT OF ANY BREACH OF ANY EXPRESS OR IMPLIED WARRANTY ON THIS PRODUCT. THIS DISCLAIMER OF WARRANTIES AND LIMITED WARRANTY ARE GOVERNED BY THE LAWS OF THE STATE OF CALIFORNIA. EXCEPT TO THE EXTENT PROHIBITED BY APPLICABLE LAW, ANY IMPLIED WARRANTY OF MERCHANTABILITY OR FITNESS FOR A PARTICULAR PURPOSE ON THIS PRODUCT IS LIMITED TO THE APPLICABLE WARRANTY AND WARRANTY PERIOD SET FORTH ABOVE. THIS WARRANTY IS SUBJECT TO CHANGE WITHOUT NOTICE. PLEASE VISIT WWW.TCLUSA.COM TO VIEW THE MOST CURRENT VERSION.

How State Law relates to this warranty

- Some states do not allow the exclusion or limitation of incidental or consequential damages, or limitations on how long an implied warranty lasts, so the above limitations or exclusions may not apply to you.
- This warranty gives you specific legal rights, and you also may have other rights that vary from state to state.

If you purchased your unit outside the United States or seek warranty coverage outside the United States: This warranty does not apply. Contact your dealer for warranty information.

Service calls which do not involve defective materials or workmanship are not covered by this warranty. Costs of such service calls are the sole responsibility of the purchaser.

Legal statement

Please note—your access and use of streaming content and channels via the TCL• Roku TV are governed by the TCL• Roku TV End User Agreement (see below). By using the TCL• Roku TV, you agree to the following disclaimer. For the avoidance of doubt, the content disclaimer set forth herein shall refer to all content and channels accessible and available on the TCL• Roku TV, including those available via the Roku® streaming platform, as well as broadcast cable.

Due to the various capabilities of the TCL• Roku TV, as well as limitations in the available content available therein, certain features, applications, and services may not be available on all TCL• Roku TV s, or in all territories. Some features on the TCL• Roku TV may also require additional peripheral devices or membership fees that are sold separately. Please visit the TCLor Roku, Inc. websites for more information on the TCL• Roku TV and content availability. The services and availability of content on the TCL• Roku TV are subject to change from time to time without prior notice.

All content and services accessible through the TCL• Roku TV belong to third parties and are protected by copyright, patent, trademark and/or other intellectual property laws. Such content and services are provided solely for your personal noncommercial use. You may not use any content or services in a manner that has not been authorized by the content owner or service provider. Without limiting the foregoing, you may not modify, copy, republish, upload, post, transmit, translate, sell, create derivative works, exploit, or distribute in any manner or medium any content or services displayed through the TCL• Roku TV.

You expressly acknowledge and agree that your use of the TCL• Roku TV is at your sole risk and that the entire risk as to satisfactory quality, performance and accuracy is with you. The TCL• Roku TV and all third party content and services are provided “as is” without warranty of any kind, either express or implied. TCLand Roku expressly disclaims all warranties and conditions with respect to the TCL• Roku TV content and services, either express or implied, including but not limited to, warranties of merchantability, of satisfactory quality, fitness for a particular purpose, of accuracy, of quiet enjoyment, and non-infringement of third party rights. TCL and Roku do not guarantee the accuracy, validity, timeliness, legality, or completeness of any content or service made available through the TCL• Roku TV and does not warrant that the TCL• Roku TV, content or services will meet your requirements, or that operation of the TCL• Roku TV will be uninterrupted or error-free. Under no circumstances, including negligence, shall TCL or Roku be liable, whether in contract or tort, for any direct, indirect, incidental, special or consequential damages, attorney fees, expenses, or any other damages arising out of, or in connection with, any information contained in, or as a result of the use of the device, or any content or service accessed by you or any third party, even if advised of the possibility of such damages.

Third party services may be changed, suspended, removed, terminated or interrupted, or access may be disabled at any time, without notice, and TCL and Roku makes no representation or warranty that any content or service will remain available for any period of time. Content and services are transmitted by third parties by means of networks and transmission facilities over which TCL and Roku have no control. Without limiting the generality of this disclaimer, TCL and Roku expressly disclaims any responsibility or liability for any change, interruption, disabling, removal of or suspension of any content or service made available through the TCL• Roku TV. TCL, Roku, the content providers, or the service providers may impose limits on the use of or access to certain services or content, in any case and without notice or liability. Any questions or requests for service relating to the content or services made available on the TCL• Roku TV should be submitted to the respective cable content or service provider or as described in the TCL• Roku TV User Guide.

In the event of a conflict between the TCL• Roku TV End User Agreement and the terms set forth in this Legal Disclaimer, the TCL• Roku TV End User Agreement shall prevail and control in all circumstances.

TCL• Roku TV End User Agreement

IMPORTANT: READ THIS AGREEMENT CAREFULLY IF YOU HAVE ANY TCL• ROKU TV. ALSO REVIEW THE IMPORTANT PRODUCT INFORMATION GUIDE BEFORE POWERING UP YOUR TCL• ROKU TV FOR THE FIRST TIME.

Purpose and Scope of Agreement

This TCL• Roku TV End User Agreement (“**Agreement**”) is the legal agreement between you (“**You**”), on the one hand, and Roku, Inc. (“**Roku**”) and TCL (“**TCL**”) (“**TCL**” on the other hand (Roku and TCL collectively referred to as “**We**”, “**Us**” or “**Our**”), governing Your use of: (i) the firmware and software that We have pre-installed on the television that You have purchased which uses the Roku platform to play digital content distributed over the Internet (“**Television**”), and the firmware and software updates Roku makes available for the Television (such firmware, software and updates, collectively, the “**Software**”); (ii) the Roku Channel Store that is accessible via the Television’s on-screen menu (“**Channel Store**”); and (iii) if downloaded by You to a mobile device, any Roku mobile application and updates thereto (collectively, “**Mobile App**”). By establishing an account at owner.roku.com (a “**Roku Account**”), using the Television, and/or downloading or using a Mobile App, You are agreeing to be bound by the terms and conditions of this Agreement. If You do not agree to these terms and conditions, You are not granted any right to use the Software or any Mobile Apps or the right to access the Channel Store. If You do not agree to these terms and conditions and You are within the allowable time period for returns under the applicable return policy, You may return the Television to the place where You obtained it for a refund, in accordance with the terms of such return policy. If You do not agree to these terms and conditions, You should not download any Mobile App. If You have downloaded any Mobile App and You do not agree to these terms and conditions, You should immediately delete it.

For purposes of this Agreement, “**Channel**” means any application that may be available from time to time in the Channel Store, including without limitation, applications to access, display or play video, audio, photos, games, text or graphics; “**Content**” means video, audio, photos,

games, text, graphics and other audio or visual materials; and “**Content Provider**” means any third party who provides video, audio, photo, games, text, graphics or other audio or visual materials that are accessible via the Channel Store and the Television.

Changes to This Agreement

Roku reserves the right to amend this Agreement at any time, in whole or in part, in its sole discretion. Such amendments shall be effective immediately upon posting of the amended Agreement on Roku’s website at www.roku.com, via the Television, or within any Mobile App. In its sole option, Roku may also notify You of the amended Agreement by sending a notice to the last email address You have provided to Roku. You agree to provide accurate and complete information when You establish Your Roku Account, and You agree to promptly update Your account information (including contact information) to keep it accurate and complete. Following the posting of the amended Agreement by any of the methods described above, continued use of Your Television or any Mobile App, or continued access to Your Roku Account, constitutes Your express agreement to be bound by the terms and conditions of the amended Agreement. You understand that, if You do not agree to the terms and conditions of the amended Agreement, Roku may terminate Your right to use the Software and any Mobile App, limit Your access to Your Roku Account and the Channel Store, and/or cease the provision of updates, upgrades or enhancements to Your Television.

Personal, Non-Commercial Use Only; Copying and Redistribution Prohibited; No Rights Except as Expressly Granted

The Software, the Channel Store and the Mobile Apps are intended for personal, non-commercial use only. You may not use them for any commercial or illegal purpose. Copying or redistribution of the Software, any Mobile App, or of any Content delivered via the Software in the Television is strictly prohibited. You may not use the Television to access or attempt to access any Content outside of the country or location authorized by Roku or the third party who provided such Content. Except as expressly provided under this Agreement, You do not acquire any intellectual property or other proprietary rights in or to the Software, the Channel Store, the Mobile Apps or the Content, including without limitation, any rights in patents, inventions, improvements, designs, trademarks, or copyrights, nor do You acquire any rights in any confidential information or trade-secrets. All rights not expressly granted to You in this Agreement are reserved by Roku or Our respective third party licensors. You may not remove or alter any trademark, logo, copyright or other proprietary notice in or on any Television, Software, Content or Mobile App.

Software Licenses

Software License

The Software is proprietary to Roku or Our respective third party licensors and may be used only with the Television. Subject to the terms of this Agreement and where appropriate, the applicable third party licenses, We grant You a non-exclusive, non-transferable license to run the Software and any updated versions provided to You by Roku, only in and as incorporated in the Television. This is a license and not a sale. You may not (i) copy, sublicense, lease, sell or rent the Software, (ii) distribute or otherwise transfer the Software to any third party except as incorporated in the Television, provided that, You do not retain any copies of the Software and the recipient of the Software reads and agrees to accept the terms and conditions of this Agreement (including all amendments); (iii) modify, adapt, alter, translate, or create derivative works of the Software; (iv) decompile, disassemble, reverse engineer or otherwise derive or attempt to derive source code from the Software; (v) defeat, bypass, circumvent or interfere with any security mechanism or access control measures, or (vi) have any of the foregoing done for You by a third party. This license does not grant any rights to obtaining future upgrades, updates or supplements to any Software.

Software Updates

ROKU RESERVES THE RIGHT TO UPDATE THE SOFTWARE FROM TIME TO TIME IN ITS SOLE DISCRETION, INCLUDING ADDING, CHANGING OR REMOVING FUNCTIONALITIES AND FEATURES, INCLUDING BUT NOT LIMITED TO, CHANGING THE USER INTERFACE OR THE MANNER IN WHICH YOU ARE ABLE TO ACCESS CONTENT VIA THE TELEVISION.

Separately Licensed Code

Notwithstanding the other provisions of this Agreement, certain components of the Software, known as “free” or “open source” software code (“**Separately Licensed Code**”), are subject to separate license terms and are not subject to the license granted above. As required by the terms of the relevant Separately Licensed Code licenses, Roku makes the Separately Licensed Code, and Roku’s modifications to it, available on Roku’s website at no charge. Please visit www.roku.com/opensource for detailed information on the use of Separately Licensed Code.

Third Party Notices

Some of the technology contained in the Television is subject to third party licenses that require that You be given the following notices:

Hoefler Foundry, Inc., d/b/a Hoefler & Frere-Jones, holds the copyright to the font used in the user interface of the Television.

MPEG LAYER-3 AUDIO CODING TECHNOLOGY LICENSED FROM FRAUNHOFER IIS AND THOMSON.

THE TELEVISION IS LICENSED UNDER THE AVC PATENT PORTFOLIO LICENSE FOR THE PERSONAL AND NON-COMMERCIAL USE OF A CONSUMER TO (i) ENCODE VIDEO IN COMPLIANCE WITH THE AVC STANDARD (“AVC VIDEO”) AND/OR (ii) DECODE AVC VIDEO THAT WAS ENCODED BY A CONSUMER ENGAGED IN A PERSONAL AND NON-COMMERCIAL ACTIVITY AND/OR WAS OBTAINED FROM A VIDEO PROVIDER LICENSED TO PROVIDE AVC VIDEO. NO LICENSE IS GRANTED OR SHALL BE IMPLIED FOR ANY OTHER USE. ADDITIONAL INFORMATION MAY BE OBTAINED FROM MPEG LA, L.L.C. SEE WWW.MPEGLA.COM.

THE TELEVISION CONTAINS TECHNOLOGY SUBJECT TO CERTAIN INTELLECTUAL PROPERTY RIGHTS OF MICROSOFT. USE OR DISTRIBUTION OF THIS TECHNOLOGY OUTSIDE OF THE TELEVISION IS PROHIBITED WITHOUT THE APPROPRIATE LICENSE(S) FROM MICROSOFT. SOME CONTENT OWNERS USE WINDOWS MEDIA DIGITAL RIGHTS MANAGEMENT TECHNOLOGY (WMDRM) AND OTHERS USE PLAYREADY DIGITAL RIGHTS MANAGEMENT TECHNOLOGY TO PROTECT THEIR INTELLECTUAL PROPERTY, INCLUDING COPYRIGHTS. THE TELEVISION USES WMDRM AND

PLAYREADY SOFTWARE TO ACCESS WMDRM-PROTECTED AND PLAYREADY-PROTECTED CONTENT. IF THE WMDRM OR PLAYREADY SOFTWARE FAILS TO PROTECT THE CONTENT, CONTENT OWNERS MAY ASK MICROSOFT TO REVOKE THE SOFTWARE'S ABILITY TO USE WMDRM OR PLAYREADY TO PLAY OR COPY PROTECTED CONTENT. REVOCATION DOES NOT AFFECT UNPROTECTED CONTENT. WHEN YOU DOWNLOAD LICENSES FOR PROTECTED CONTENT, YOU AGREE THAT MICROSOFT MAY INCLUDE A REVOCATION LIST WITH THE LICENSES. CONTENT OWNERS MAY REQUIRE YOU TO UPGRADE WMDRM OR PLAYREADY TO ACCESS THEIR CONTENT. IF YOU DECLINE AN UPGRADE, YOU WILL NOT BE ABLE TO ACCESS CONTENT THAT REQUIRES THE UPGRADE.

USE OF THE TELEVISION IS LIMITED TO PRIVATE NON-PROFESSIONAL USE BY CONSUMERS FOR LICENSED CONTENT. NO RIGHTS ARE GRANTED FOR PROFESSIONAL USE OR FOR USE OF THE TELEVISION IN COMBINATION WITH TELEVISIONS NOT LICENCED UNDER THE MPEG-1 OR MPEG-2 AUDIO STANDARDS.

THE TELEVISION CONTAINS TECHNOLOGY SUBJECT TO CERTAIN INTELLECTUAL PROPERTY RIGHTS OF SIGMA DESIGNS, INC. AND ITS LICENSORS. ANY USE OR DISTRIBUTION APART FROM THE TELEVISION, AND ANY MODIFICATION, ALTERATION, REVERSE-ENGINEERING, DECOMPILING, DISASSEMBLING OR ATTEMPT TO DERIVE THE SOURCE CODE OF THE INTELLECTUAL PROPERTY OF SIGMA DESIGNS, INC. OR ITS LICENSORS, ARE STRICTLY PROHIBITED EXCEPT AS AUTHORIZED BY SIGMA DESIGNS, INC. WITH RESPECT TO YOU, SIGMA DESIGNS, INC. AND ITS LICENSORS, SIGMA DESIGNS, INC. AND ITS LICENSORS OWN THE TITLE TO ALL INTELLECTUAL PROPERTY RIGHTS IN THE TECHNOLOGY DESCRIBED IN THIS PARAGRAPH.

Access to Content: Roku Accounts

Additional Definitions Applicable to this Section:

- **"Fee-Based Programming"** means the specific Content available to end users of the Television who agree to pay the applicable fee to access the Content.
- **"One-Time Fee"** means a single one-time charge payable for access to selected Fee-Based Programming.
- **"Private Channel"** means a Channel which may be accessed by entering a developer-provided linking code on the Roku website.
- **"Public Channel"** means a Channel that is generally available to all Roku users and is visible in the Channel Store.
- **"Subscription Fee"** means a monthly or annual fee charged for access to selected Fee-Based Programming.

Establishing an Account

The Television is enabled to permit Your access to Content provided by various Content Providers. In order to access Content, You are required to establish a Roku Account at owner.roku.com and provide Your credit card number or PayPal account information against which Your Fee-Based Programming fees will be charged. At Your option, a PIN code may be required to access certain Fee-Based Programming. If You prefer to use a PIN, You will choose Your PIN when establishing Your Roku Account preferences. Through Your Roku Account, You will be provided the opportunity to review monthly summaries of Your charges. In addition, for some of the Content, You may be required to maintain a valid and active account in good standing with one or more Content Providers. You must adhere to Roku's terms of service and to the terms of service of any Content Provider whose Content You choose to access. See www.roku.com/channels#!now-playing for a list of Content Providers for the Television. Roku may add or remove Content Providers, Channel and/or Content from time to time, in its sole discretion. Roku reserves the right to remove, from Your Television, Your access to any Content and/or Channel if Roku has reason to believe that the Television is stolen, hacked or compromised, or that the Content or Channel is not properly authorized or licensed, violates any law, or has been offered by a Content Provider in violation of any agreement between the Content Provider and Roku. You are responsible for ensuring that any age-restricted Content is not viewed by any person not meeting the applicable age limits, as specified by law, regulation or the Content Provider.

Fees and Charges

Where Roku manages the handling and processing of Your payments for Fee-Based Programming, the following terms apply:

One-Time Fee Programming. For Public Channels, Your account will be charged in full when You confirm Your purchase of access to the Channel. For Private Channels, You will be charged after the Channel appears as an option in Your Channel line-up and after You have confirmed Your purchase of access to the Channel. For the Content and services purchased from within any Public Channel or Private Channel, Your account will be charged in full when You confirm the purchase.

Subscription Fee Programming. The timing of Your initial selection of subscription Fee-Based Programming will provide the basis for Your billing dates for all future monthly and yearly Subscription Fees. All Subscription Fees will be charged for the full term of the applicable subscription period, i.e., for the month or year, as applicable, at the time You order the subscription, except where pro-rated monthly billing applies. Where the first month is pro-rated, the second and all subsequent charges applied to Your account will be for the full monthly or yearly Subscription Fee, as applicable.

Sales Tax. Your purchases may be subject to sales tax, which may not be included in the prices shown on the purchase screen. If an item You purchased is subject to sales tax, such amount will be reflected on the invoice for that purchase. The amount of tax charged on Your purchase will depend upon many factors, including the item purchased and the applicable tax rate in effect at the time of Your purchase. Factors can change between the time You place an order and the time of credit card charge authorization, which could affect the calculation of sales taxes.

Subscription Renewals and Cancellations. All subscriptions will automatically renew until cancelled by You. Details for how to cancel a subscription are available by entering the key words "cancel subscription" in the "Ask a Question" box on www.roku.com/support. If a subscription is cancelled mid-way through a subscription period, the subscription will end at the end of the subscription period.

You will continue to receive the Content until the end of the subscription period, and fees for the remainder of the subscription period will not be refunded.

Credit/Refund Policy. Credits and refunds will be issued only in accordance with the terms posted at www.roku.com/support. For details, go to www.roku.com/support and enter the key words “credit policy” in the “Ask a Question” box.

Privacy Policy and Consent to Use of Data

Roku’s privacy policy, available at www.roku.com/about/privacy (“**Privacy Policy**”), explains Roku’s policies regarding the collection, use, and disclosure of information provided by or collected from You via the Television, Roku’s websites and/or the Mobile Apps. By agreeing to be bound by the terms and conditions of this Agreement, You are agreeing to the collection, use, and disclosure of Your information as described in the Privacy Policy. You should review the Privacy Policy before establishing Your Roku Account, before linking the Television to any existing Roku Account, and before using the Television and/or Mobile Apps.

Advertising and Promotional Messages

Roku and the Content Providers reserve the rights to deliver and display advertising and promotional messages to You via the Software incorporated in the Television or the Mobile Apps, and to include such advertising and promotional messages in or with any user interface, notice, or Content that is displayed via the Software incorporated in the Television or the Mobile Apps.

No Warranty from Roku

This Agreement governs only Your access to and use of the Software, the Mobile App, the Channel Store, and Your Roku Account. Your warranty with respect to the Television and its operation (including the operation of the Software incorporated in the Television) is provided solely by TCL as set forth in the Important Product Information Guide, and not by Roku. **Roku offers no warranty to You under this Agreement.**

WITHOUT LIMITING THE GENERALITY OF THE FOREGOING DISCLAIMER, TO THE MAXIMUM EXTENT PERMITTED BY APPLICABLE LAW, THE TELEVISION, THE MOBILE APPS, THE SEPARATELY LICENSED CODE, THE SOFTWARE, THE CHANNEL STORE, AND ANY SERVICES PERFORMED OR PROVIDED BY THE FOREGOING ARE PROVIDED “AS IS” AND “AS AVAILABLE”, WITH ALL FAULTS AND WITHOUT WARRANTY OF ANY KIND, AND ROKU HEREBY DISCLAIMS ALL WARRANTIES AND CONDITIONS WITH RESPECT TO ANY OF THE FOREGOING, EITHER EXPRESS, IMPLIED OR STATUTORY, INCLUDING, BUT NOT LIMITED TO, THE IMPLIED WARRANTIES AND/OR CONDITIONS OF MERCHANTABILITY, OF SATISFACTORY QUALITY, OF FITNESS FOR A PARTICULAR PURPOSE, OF RELIABILITY OR AVAILABILITY, OF ACCURACY, OF QUIET ENJOYMENT, OF QUIET POSSESSION, OF WORKMANLIKE EFFORT, OF LACK OF VIRUSES, OR REASONABLE CARE AND SKILL, AND NON-INFRINGEMENT OF THIRD PARTY RIGHTS. ROKU DOES NOT WARRANT (I) AGAINST INTERFERENCE WITH YOUR ENJOYMENT OF THE TELEVISION, THE MOBILE APPS, THE SOFTWARE, THE SEPARATELY LICENSED CODE, OR THE CHANNEL STORE, (II) THAT THE FUNCTIONS CONTAINED IN OR SERVICES PERFORMED OR PROVIDED BY ANY OF THE FOREGOING WILL MEET YOUR REQUIREMENTS, (III) THAT THE OPERATION OF ANY OF THE FOREGOING WILL BE UNINTERRUPTED OR ERROR-FREE, OR (IV) THAT DEFECTS WILL BE CORRECTED. NO ORAL OR WRITTEN INFORMATION OR ADVICE GIVEN BY US OR OUR RESPECTIVE AUTHORIZED REPRESENTATIVES SHALL CREATE ANY WARRANTY.

Some jurisdictions do not allow exclusions or limitations on implied warranties, so the foregoing limitations of warranties may not apply to You. You may also have other rights that vary from jurisdiction to jurisdiction.

Limitation of Liability

TO THE EXTENT NOT PROHIBITED BY APPLICABLE LAW, IN NO EVENT SHALL WE OR OUR RESPECTIVE LICENSORS AND/OR SUPPLIERS BE LIABLE FOR (A) ANY PERSONAL INJURY OR PROPERTY DAMAGE; OR (B) ANY CONSEQUENTIAL, SPECIAL, EXEMPLARY, INCIDENTAL, INDIRECT OR PUNITIVE DAMAGES, OR FOR LOSS OF REVENUE OR PROFITS OR DATA OR USE OR FOR THE COST OF SUBSTITUTE GOODS, REGARDLESS OF THE THEORY (WHETHER BASED IN CONTRACT, TORT (INCLUDING NEGLIGENCE) OR OTHERWISE) ARISING OUT OF, OR IN CONNECTION WITH, ANY TELEVISION, ANY ROKU ACCOUNT, THE CHANNEL STORE, THE MOBILE APPS, THE SOFTWARE, THIRD PARTY CONTENT, THE SEPARATELY LICENSED CODE, OR YOUR USE THEREOF. SOME JURISDICTIONS DO NOT ALLOW LIMITATION OF LIABILITY FOR CERTAIN DAMAGES, SO THE EXCLUSIONS SET FORTH ABOVE MAY NOT APPLY TO YOU. TO THE EXTENT ALLOWED BY LAW, AND OTHER THAN AS MAY BE REQUIRED BY APPLICABLE LAW FOR PERSONAL INJURY CASES, YOU AGREE THAT (I) THE TOTAL CUMULATIVE LIABILITY OF ROKU, ROKU’S LICENSORS AND/OR ROKU’S SUPPLIERS, INCLUDING LIABILITY RELATING TO ANY TELEVISION, ANY ROKU ACCOUNT, THE CHANNEL STORE, THE SOFTWARE, THE THIRD PARTY CONTENT, THE SEPARATELY LICENSED CODE, AND THE MOBILE APPS SHALL NOT EXCEED ONE HUNDRED UNITED STATES DOLLARS (US\$100), AND (II) ROKU, ITS LICENSORS AND/OR SUPPLIERS SHALL NOT BE LIABLE TO YOU UNDER THIS AGREEMENT FOR ANY DIRECT DAMAGES ARISING OUT OF, OR IN CONNECTION WITH, THE TELEVISION. YOUR REMEDY, IF ANY, WITH RESPECT TO THE TELEVISION, SHALL BE SOLELY AGAINST (A) THE SELLER FROM WHOM YOU PURCHASED IT AND (B) TCL, AS SET FORTH IN ACCORDANCE WITH THE IMPORTANT PRODUCT INFORMATION GUIDE PROVIDED BY TCL. THE FOREGOING LIMITATIONS SHALL APPLY EVEN IF THE REMEDY PROVIDED HEREIN FAILS OF ITS ESSENTIAL PURPOSE AND EVEN IF WE OR OUR LICENSORS OR SUPPLIERS HAVE BEEN ADVISED OF THE POSSIBILITY OF SUCH LIABILITY.

Additional Terms Applicable to Mobile Apps

License

The Mobile Apps are licensed, not sold, to You for use only under the terms of this Agreement. Roku, as the licensor, reserves all rights not expressly granted to You. This license granted to You by Roku for the Mobile Apps is limited to a non-exclusive, non-transferable license to use the Mobile Apps for personal and non-commercial purposes solely on any mobile device that You own or control and as permitted by the usage rules set forth in any application store terms and conditions and only within the country or location authorized by Roku. This license does not grant any rights to obtaining future upgrades, updates or supplements to any Mobile App.

Usage Rules

You may not commercialize the Mobile Apps in any way. You will not, and You will not allow any person to, copy sublicense, lease, sell or rent the Mobile Apps or any part thereof, to analyze it by means of reverse engineering, to decompile, disassemble, attempt to derive the source

code of, modify, or create derivative works of the Mobile Apps, or of any updates thereto or any part thereof (except as and only to the extent any foregoing restriction is prohibited by applicable law or to the extent as may be permitted by the licensing terms governing use of any Separately Licensed Code included with a Mobile App). Any attempt to do so is a violation of the rights of Roku and its licensors. If You breach this restriction, You may be subject to prosecution and damages. The terms of this license will govern any upgrades provided by Roku to a Mobile App, unless such upgrade is accompanied by a separate license in which case the terms of that license will govern.

Consent to Use of Data

You agree that Roku or a third party contracted by Roku, may collect and use technical and usage data and related information, including but not limited to, information about Your device, system and software, peripherals and Mobile App usage that is gathered periodically to facilitate the provision of updates, product support and other services (if any) to You related to the Mobile App. Roku may use this and other information it collects about You as described in its Privacy Policy, available at www.roku.com/about/privacy.

Export Controls

You agree not to download any Content, Mobile App, or Software, nor otherwise export or re-export the Television or Mobile Apps or the Software into (or to a national or resident of) Cuba, Iraq, Libya, North Korea, Iran, Syria or any other country as to which the United States has embargoed goods, or to anyone on the U.S. Treasury Department's List of Specially Designated Nationals or the U.S. Commerce Department's Table of Denial Orders. By using the Television, the Channel Store, the Software or the Mobile Apps, You are representing and warranting that You are not located in, under the control of, or a national or resident of any such country or on any such list.

Roku Reserves the Right to Change Policies and Web Pages

The policies and other content of the Roku web pages referred to in this Agreement may be changed by Roku from time to time in its sole discretion, without notice to You.

Dispute Resolution by Binding Arbitration, with Class Action Waiver and Choice of Law

1. You and Roku agree to be bound by the procedures set forth below to resolve any and all claims arising out of or relating to any aspect of the relationship between You and Roku, whether based in contract, statute, tort, fraud, misrepresentation or any other legal theory, including but not limited to, claims relating to this Agreement, its formation, enforceability, performance or breach, and claims related to advertising, the Software, the Television, the Channel Store or the Mobile Apps (as applicable). Each such claim is referred to individually as "Claim" and collectively as "Claims".
2. **YOU AND ROKU AGREE THAT, EXCEPT FOR THE CLAIMS IDENTIFIED IN PARAGRAPH 4 BELOW, ANY AND ALL CLAIMS BETWEEN YOU AND ROKU SHALL BE FINALLY SETTLED BY BINDING ARBITRATION.** The arbitration shall take place in Santa Clara County, California, and shall be administered by the American Arbitration Association ("AAA") pursuant to the AAA's then-current rules, including (if applicable) the AAA's Supplementary Procedures for Consumer-Related Disputes. Please be aware there is no judge or jury in arbitration. Arbitration procedures are simpler and more limited than the rules applicable in court, and review of the arbitrator's decision by a court is limited. **YOU AND ROKU FURTHER AGREE THAT EACH MAY BRING CLAIMS AGAINST THE OTHER ONLY ON AN INDIVIDUAL BASIS AND NOT AS A PLAINTIFF OR CLASS MEMBER IN ANY PURPORTED CLASS OR REPRESENTATIVE ACTION OR PROCEEDING. THE ARBITRATOR MAY NOT CONSOLIDATE OR JOIN MORE THAN ONE PERSON'S CLAIM AND MAY NOT PRESIDE OVER ANY CONSOLIDATED, REPRESENTATIVE OR CLASS PROCEEDING. ALSO, THE ARBITRATOR MAY AWARD RELIEF (INCLUDING MONETARY, INJUNCTIVE OR DECLARATORY RELIEF) ONLY ON AN INDIVIDUAL BASIS AND MAY NOT AWARD ANY FORM OF CONSOLIDATED, REPRESENTATIVE OR CLASS-WIDE RELIEF.** Notwithstanding any provision in these terms to the contrary, if the class-action waiver in this provision is deemed invalid or unenforceable, or if an arbitration of a Claim between You and Roku is allowed to proceed on a class basis, then neither You nor Roku are entitled to arbitrate such Claim. This arbitration provision is subject to the Federal Arbitration Act. The arbitrator's award shall be binding on You and Roku, and may be entered in any court of competent jurisdiction.
3. Information on AAA and how arbitration is initiated can be found at www.adr.org or by calling 800-778-7879. For Claims between You and Roku of \$75,000 or less, You will be responsible for the initial arbitration filing fee, up to the amount of the initial filing fee if You were to initiate a lawsuit against Roku based on such Claims in court. If the arbitrator finds such Claims to be non-frivolous, Roku will pay any difference in such filing fees plus the arbitrator fees. For Claims between You and Roku in excess of \$75,000, if You are able to demonstrate that the costs of arbitration will be prohibitive as compared to the costs of litigation, Roku will pay as much of Your actual filing fees and the arbitrator fees for the arbitration as the arbitrator deems necessary to prevent the arbitration from being cost-prohibitive as compared to the cost of litigation.
4. This agreement to arbitrate does not apply to any Claim (i) in which a party is attempting to protect its intellectual property rights (such as its patent, copyright, trademark, trade secret, or moral rights, but not including its privacy or publicity rights), or (ii) that may be brought in small-claims court.
5. If the agreement between You and Roku to arbitrate in this provision is found to be invalid, unenforceable or inapplicable to a given Claim between You and Roku, then any and all proceedings to resolve such Claim must be brought exclusively in a federal court of competent jurisdiction in the Northern District of California or in a state court in Santa Clara County, California. You hereby irrevocably consent to the exclusive jurisdiction and venue of such courts.
6. **30-Day Right to Opt Out:** You have the right to opt out of this agreement to arbitrate by sending a written notice of Your decision to opt out to the following address: Legal Department, Roku Inc., 12980 Saratoga Avenue, Suite D., Saratoga, California 95070; provided that, such notice shall be postmarked on or before the 30th day after the first to occur of the following events: (i) the purchase of Your Television, (ii) Your receipt of the Television, (iii) the establishment of a new Roku Account if You do not already have a Roku Account prior to using Your Television, (iv) using or accessing the Channel Store, or (v) using, accessing or downloading

the Software or any Mobile App. Your notice should include Your full name, Your current postal address, telephone number and email address, the product name and serial number for Your Television, and a copy of the original proof of purchase for Your Television. If You timely send a notice in compliance with this paragraph 6, the agreement to arbitrate will not apply to either You or Roku. If You do not timely send this notice, then You agree to be bound by this agreement to arbitrate.

7. Notwithstanding any provision in this Agreement to the contrary, You agree that, if Roku seeks to delete or materially modify the agreement to arbitrate described herein, any such deletion or modification will not apply to any individual Claim between You and Roku, of which You have notified Roku prior to such modification.

Choice of Law

This Agreement shall be governed by the laws of the State of California, as if entered into by residents of California, without giving effect to any conflict of laws principles that may provide the application of the law of another jurisdiction.

Miscellaneous

This Agreement is the final, complete and exclusive agreement between You, on the one hand, and Roku and TCL, on the other hand, relating to the Television, the Channel Store, the Software and the Mobile Apps (as applicable), and supersedes all prior or contemporaneous proposals, advertisements, representations, understandings, or agreements relating thereto, whether oral or written; provided that, notwithstanding the foregoing, this Agreement is not intended to modify or supersede the Important Product Information Guide and other documentation provided to You with the Television. No waiver or modification of this Agreement will be valid unless signed by Roku, TCL and You. Your right to use the Television, the Software, the Channel Store, Your Roku Account, the Software, or the Mobile Apps (as applicable) will immediately terminate upon Your breach of any applicable provision of this Agreement. The waiver of a breach of any term hereof will in no way be construed as a waiver of any other term or breach hereof. If any provision of this Agreement is held by a court of competent jurisdiction to be invalid or unenforceable, the remaining provisions of this Agreement will remain in full force and effect.

Contact Information

If You desire to contact Roku, please send Your correspondence by mail to

Roku, Inc.
12980 Saratoga Avenue, Suite D
Saratoga, CA 95070

or by email to customerservice@roku.com.

If You desire to contact TCL, please send your correspondence by mail to

TCL
2455 Anselmo Dr.
Corona, CA 92879

or by email at support@tcl.com.

Additional TCL Legal Statements

FCC Statement

Note: This equipment has been tested and found to comply with the limits for a class B digital Device, pursuant to part 15 of the FCC Rules. These limits are designed to provide reasonable protection against harmful interference in a residential installation. This equipment generates, uses and can radiate radio frequency energy and, if not installed and used in accordance with the instructions, may cause harmful interference to radio Communications. However, there is no guarantee that interference will not occur in a particular installation. If this equipment does cause harmful interference to radio or television reception, which can be determined by turning the equipment off and on, the user is encouraged to try to correct the interference by one or more of the following measures:

- Reorient or relocate the receiving antenna.
- Increase the separation between the equipment and the receiver.
- Connect the equipment into an outlet on a circuit different from that to which the receiver is connected.
- Consult the dealer or an experienced radio/TV technician for help.

This Class B digital apparatus complies with Canadian ICES-003.

Declaration of Conformity

This device complies with part 15 of the FCC Rules. Operation is subject to the following two conditions: (1) This device may not cause harmful interference and (2) This device must accept any interference received, including interference that may cause undesired operation.

Please do not send any products to the California address listed in this manual or on the carton. This will only add delays in service for your product.

Macrovision statement

This product incorporates copyright protection technology that is protected by U.S. patents and other intellectual property rights. Use of this copyright protection technology must be authorized by Macrovision, and is intended for home and other limited viewing uses only unless otherwise authorized by Macrovision. Reverse engineering or disassembly is prohibited.

U.S. Patent Nos. 5,583,936; 6,836,549; 5,315,448; 6,381,747; 6,501,842; and 7,050,698.

HDMI®

This TV incorporates High-Definition Multimedia Interface (HDMI®) technology.

HDMI®, the HDMI® logo and High-Definition Multimedia Interface are trademarks or registered trademarks of HDMI Licensing LLC.



Dolby Digital

Manufactured under license from Dolby Laboratories.

"Dolby" and the double-D symbol are registered trademarks of Dolby Laboratories.

