

TCL • Roku TV

User Guide

Models: 43UP130, 50UP130, 55UP130

Version 7.0

English



Illustrations in this guide are provided for reference only and may differ from actual product appearance. Product design and specification may be changed without notice.

Copyright

Portions © 2016 TCL and Roku, Inc. All rights reserved. ROKU, the ROKU Logo, and “NOW THIS IS TV” are trademarks and/or registered trademarks of Roku, Inc. © 2016 Material in this User Manual is the property of TCL and its subsidiaries, and Roku, Inc. and is protected under US and International copyright and/or other intellectual property laws. Reproduction or transmission of the materials, in whole or in part, in any manner, electronic, print, or otherwise, without the prior written consent of the TCL and Roku, Inc. is a violation of TCL and Roku, Inc.’s rights under the aforementioned laws.

No part of this publication may be stored, reproduced, transmitted or distributed, in whole or in part, in any manner, electronic or otherwise, whether or not for a charge or other or no consideration, without the prior written permission of Roku, Inc. and TCL

Requests for permission to store, reproduce, transmit or distribute materials shall be made to both of the following addresses:

TCL

and

Roku
Roku, Inc.
150 Winchester Circle
Los Gatos, CA 95032

Product name: TCL • Roku TV
Document name: TCL • Roku TV User Guide
Document revision: 7.0.9
Publication date: 18 Mar, 2016

Contents

TCL • Roku TV	i
Important information	iv
Important safety instructions.....	i
Welcome	1
The new standard in Smart TVs.....	1
Get the most out of your new TV	1
Connections and setup	4
Set up your new TV	4
Connect your TV	7
AC power	10
Remote control batteries	10
Roku TV Remote control	11
Getting around	11
Guided Setup	15
Starting Guided Setup	15
Setting up your TV	16
Connected Home screen	23
Non-connected Home screen.....	24
Benefits of connecting	25
Connecting brings out your TV's full potential!.....	25
What is streaming?.....	25
But what if I didn't connect my TV?	27
Setting up Antenna TV	28
Why do I have to set up the TV tuner?.....	28
How do I set up the TV tuner?.....	28
Using your TCL Roku TV	32
Status light.....	32
Panel buttons	33
Standby mode energy savings.....	33

Watching broadcast TV channels	33
Switching TV inputs	35
Playing content from USB storage devices	35
Playing content from local network media servers	36
Using your TV in a hotel or dorm room	36
Adjusting TV settings	39
Settings menu	39
Options menu	40
Advanced picture settings	41
Changing privacy settings	43
My Feed	45
Movies Coming Soon	45
Movies, TV shows, and people	45
Searching for something to watch	46
How do I search?	46
I found a show, now what?	47
Following on Roku	47
Recent Searches	48
Using the Roku Channel Store	49
Customizing your TV	51
Rearrange tiles	51
Edit broadcast TV channel lineup	52
Rename inputs	52
Remove unwanted tiles	53
Change themes	53
Change sound effects volume	54
Configure power settings	54
Configure parental controls	55
More settings	63
Changing network settings	63
Changing caption settings	64
Changing time settings	65
Scanning for broadcast TV channels again	66
Setting the HDMI mode	66

Using the TV in a home theater.....	67
Restarting the TV.....	70
Resetting the TV.....	70
Changing your Roku Channel Store PIN preference.....	72
Getting system updates.....	72
Other devices	75
Screen Mirroring your phone or tablet.....	75
Getting and using the Roku mobile app.....	75
Using a universal remote.....	75
FAQ.....	76
Additional TCL • Roku TV Legal Statements.....	87

Important information

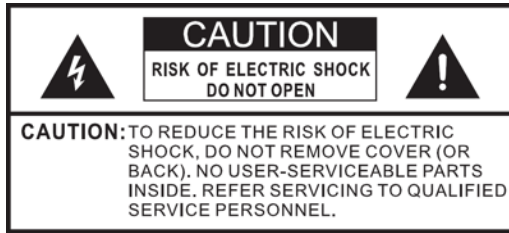

The lightning flash with arrowhead symbol, within an equilateral triangle is intended to alert the user to the presence of uninsulated dangerous voltage within the product's enclosure that may be of sufficient magnitude to constitute a risk of electric shock.



The exclamation point within an equilateral triangle is intended to alert the user to the presence of important operating and maintenance (servicing) instructions in the literature accompanying the product.



This symbol indicates that this product incorporates double insulation between hazardous main voltage and user accessible parts. When servicing, use only identical replacement parts.

WARNING: To reduce the risk of fire or electric shock, do not expose this product to rain or moisture. This product should not be exposed to dripping or splashing. No objects filled with liquids, such as vases, should be placed on or near the product.

WARNING: The TV is unstable if it is not properly attached to the base or mounted to the wall. Be sure to follow the base or wall mounting instructions provided in the User's Guide to ensure your safety.

WARNING: Do not expose batteries to excessive heat such as sunshine, fire, and so forth.

Proper operating voltage

Refer to the identification/rating label located on the back panel of your product for its proper operating voltage.

Cable TV installer notice of proper grounding

This reminder is provided to call your attention to Article 820-40 of the National Electrical Code (Section 54 of the Canadian Electrical Code, Part 1) which provides guidelines for proper grounding and, in particular, specifies that the cable ground should be connected to the grounding system of the building as close to the point of cable entry as practical.

Installation location

Important: This television is a table model and is designed to sit on a firm, flat surface. Don't place the TV on soft carpeting or similar surface because the ventilation slots on the bottom of the unit will be blocked, resulting in reduced lifetime from overheating. To assure adequate ventilation for this product, maintain a spacing of 4 inches from the top and side of the TV receiver and 2 inches from the rear of the TV receiver and other surfaces.

Also, make sure the stand or base you use is of adequate size and strength to prevent the TV from being accidentally tipped over, pushed off, or pulled off the stand. This could cause personal injury and/or damage to the TV. Refer to the Important Safety Instructions on the following pages.

Low power standby mode

The Power button (indicated by the power symbol) on this TV and its remote control puts the TV into a very low power standby mode but does not completely turn the power off. To completely shut the power off, you must disconnect the power cord from the power outlet. The mains plug/appliance coupler is used as a disconnect device. Therefore, you should be sure that the TV is installed in a manner to enable the power cord to be disconnected when necessary.

Note: In situations where the power plug or appliance coupler is used as the disconnect device, the disconnect device shall remain readily accessible and operable.

Product Registration

Please register your TCL Roku TV purchase on-line at www.TCLUSA.com. It will make it easier to contact you should it ever be necessary. Registration is not required for warranty coverage.

Product Information

Keep your sales receipt to obtain warranty parts and service and for proof of purchase. Attach it here and record the serial and model numbers in case you need them. These numbers are located on the product.

Model No. _____

Serial No. _____

Purchase Date _____

Dealer/Address/Phone _____

Important safety instructions

1. **Read instructions.** Read all the safety and operating instructions before operating the product.
2. **Retain instructions.** Retain the safety and operating instructions for future reference.
3. **Heed warnings.** Adhere to all warnings on the product and in the operating instructions.
4. **Follow instructions.** Follow all operating and use instructions.
5. **Water and moisture.** Do not use this product near water.
6. **Cleaning.** Clean only with a dry cloth.
7. **Ventilation.** Do not block any ventilation openings. Install in accordance with the manufacturer's instructions.
8. **Heat.** Do not install near any heat sources such as radiators, heat registers, stoves, or other apparatus (including amplifiers) that produce heat.
9. **Grounding or polarization.** Do not defeat the safety purpose of the polarized or grounding-type plug. A polarized plug has two blades with one wider than the other. A grounding type plug has two blades and a third grounding prong. The wide blade or the third prong are provided for your safety. If the provided plug does not fit into your outlet, consult an electrician for replacement of the obsolete outlet.
10. **Power cord protection.** Protect the power cord from being walked on or pinched particularly at plugs, convenience receptacles, and the point where it exits from the product.
11. **Accessories.** Use only attachments/accessories specified by the manufacturer.
12. **Stand/cart.** Use only with the cart, stand, tripod, bracket, or table specified by the manufacturer, or sold with the apparatus. When a cart is used, use caution when moving the cart/apparatus combination to avoid injury from tip-over.
13. **Power.** Unplug this apparatus during lightning storms or when unused for long periods of time.
14. **Servicing.** Refer all servicing to qualified service personnel. Servicing is required when the apparatus has been damaged in any way, such as power-supply cord or plug damaged, liquid has been spilled or objects have fallen into the apparatus, the apparatus has been exposed to rain or moisture, does not operate normally, or has been dropped.
15. If an outside antenna or cable system is connected to the product, be sure the antenna or cable system is grounded so as to provide some protection against voltage surges and built-up static charges. Section 810 of the National Electrical Code, ANSI/NFPA No. 70-2011 (Section 54 of Canadian Electrical Code, Part 1) provides information with respect to proper grounding of the mast and supporting structure, grounding of the lead-in wire to an antenna-discharge unit, size of grounding conductors, location of antenna-discharge unit, connection to grounding electrodes, and requirements for the grounding electrode. See following example:

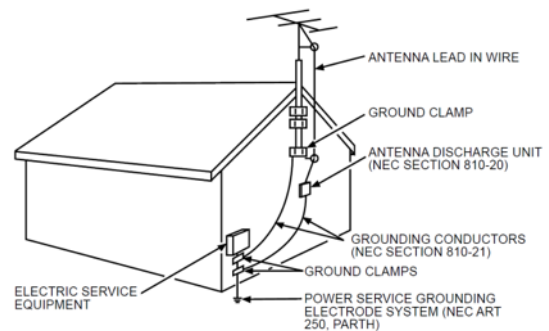

Welcome

Congratulations on the purchase of your new TCL Roku TV! Discover the joy of endless entertainment. After it's set up, you'll be able to access a world of streaming content channels that may include Netflix, YouTube, Crackle, CNET and literally thousands more.

Important: *Your TCL Roku TV receives automatic updates from time to time, enabling new content and features. This User Guide explains how to use your TCL Roku version 7.0 TV. Your TV might update to a newer version as soon as you connect to the Internet. If it does, you might notice some differences between the TV and the information in this User Guide. To determine the current version of your Roku TV, go to **Settings > System > About** after you complete Guided Setup.*

The new standard in Smart TVs

Welcome to TV like you've most likely never seen before—a home screen that you can personalize with your favorite devices and streaming channels. Choose from hundreds of thousands of streaming movies and TV episodes, plus music, sports, kids, family, international and much more. You should never run out of things to watch.

Note: *A paid subscription or other payments may be required for some channels. Channel availability is subject to change and varies by country. Not all content is available in countries or regions where Roku products are sold.*

Get the most out of your new TV

Follow these simple steps to get the most out of your new TV.

1. Connect to the Internet
 - It's simple, it's easy, and it will unlock a world of entertainment. All you need is a network connection. There are hundreds of free streaming channels, subscriptions services like Netflix and Spotify, convenient ways to rent or buy a favorite film or show with Google Play and Cineplex and more.

2. Pick your favorite streaming channels

- Find the entertainment you love. From the latest blockbuster movies to your favorite TV shows, with tons of live sports, a broad selection of music streaming channels, popular programming in a dozen international languages, 24x7 live news and so much more, your new Roku TV has your sweet spot. A paid subscription or other payments may be required for some channels.

3. Personalize your home screen

- Put your favorite broadcast TV, streaming channels, gaming console and other devices front-and-center on the home screen. No more flipping through inputs or wading through complicated menus. You can even personalize the names of each input and move tiles around so your most-often used devices and streaming channels are only a click away.

4. Search for your favorite movie, TV show, actor, or director

- Once you're connected to the internet, you can easily search across top streaming channels by movie or TV show title, actor or director—all from one place. Search results are organized by price so you can always see the best priced option. A paid subscription or other payments may be required for some channels.

5. Send your personal media to the big screen

- Send personal photos, videos, and music from your compatible smartphone or tablet to the TV screen in just a few taps. Plus, with Netflix and YouTube apps and any applicable subscription, send movies, shows, sport highlights, and more directly to your TV.

Note: *The Roku app for Microsoft Windows devices does not cast videos.*

6. Follow movies coming soon

- Use My Feed to choose from and follow a list of upcoming movies, and then watch for alerts each time one of your followed movies becomes available or changes price.

Note: *My Feed is not available in the Roku App for Windows devices in the United States or Canada.*

7. Take charge with a smartphone or tablet

- Control your TV with the included remote or from your compatible smartphone or tablet with the free mobile app for iOS, Android, and Windows devices. Browse channels, view My Feed, and even search with voice via the free mobile app.

Note: *Voice search and My Feed are not available in the Roku app for Windows devices.*

- Mirror your compatible smartphone or tablet on your TV. Share videos, photos, web pages, and more from compatible devices.

- Use your compatible smartphone or tablet to connect your Roku TV to the types of networks found in hotels and college dorms, where you may have to agree to terms, enter codes, or provide identifying information.

Note: *Using your Roku TV on a restricted public network requires wireless availability and use of your network-connected smartphone, tablet, or computer to authenticate access to your account. Your TV must already be linked to your Roku account and activated. Also, you must use your Roku TV remote control, because the Remote feature of the Roku mobile app does not work on restricted public networks. Streaming content might be limited due to your geographic location or because of restrictions imposed by the wireless network host.*

Many features work with top mobile devices. Go to support.roku.com for device compatibility information.

Let's get started.

Connections and setup

Before initial setup

Protect against power surges

- Connect all components before you plug any power cords into the wall outlet or power strip.
- NEVER plug your TCL Roku TV into an outlet that is controlled by a wall switch.
- Turn off the TV before you connect or disconnect any cables.
- Make sure all antennas and cables are properly grounded. Refer to the Important Safety Instructions.

Safety information

- Prevent TV from overheating by placing in an area with good ventilation.
- Do not block ventilation holes on the TV. Position the TV so air can circulate freely on all sides.
- Do not stack objects on the TV.
- If you place the TV on a stand, make sure you allow adequate ventilation.
- If you connect an audio receiver or amplifier to the TV, place it on the top shelf so the heated air will not overheat the TV.

Avoid audio interference

- Position cables properly; insert each cable firmly into the designated jack.
- Route all cables down one side of the back of the TV instead of straight down the middle.
- If your antenna uses 300-ohm twin lead cables, do not coil the cables.
- Keep twin lead cables away from audio/video cables.

Avoid direct light

Do not place the TV where sunlight or room lighting is directed toward the screen. Use soft or indirect lighting.

Set up your new TV

Open the box and remove the TV and other items. Be careful, the TV is heavy! We strongly recommend that two people unbox the TV.

Be sure to check all the foam packaging as the stands from some TV's are stored in the foam for protection.

What's in the box



TCL Roku TV

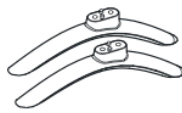

TV stands

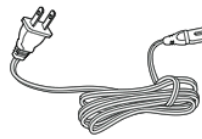

Power cable



Cable clip



4 x Phillips screws
(M5X35mm)

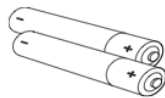

2 x AA batteries
for remote

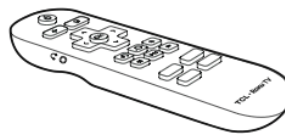

TV remote

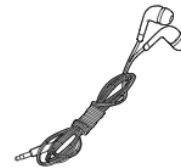

In-ear headphones

To mount on a wall

If you are mounting your TCL Roku TV to the wall, do not attach the TV base stand or TV stand column.

To mount your TV to the wall, purchase the one of the following VESA wall mounts:

- **43" model** VESA 100 x 200, M6 x 12mm screws
- **50" model** VESA 200 x 200, M6 x 12mm screws
- **55" model** VESA 200 x 200, M6 x 12mm screws

The VESA number is the horizontal and vertical measurement of the mounting holes. For example, 100 x 200 indicates that the mounting holes are spaced 100mm horizontally and 200mm vertically.

Follow the directions supplied with the wall mount to mount the TV to the wall.

Caution: Your wall mount must be able to bear a minimum of five times the TVs net weight to avoid damage.

Note: *The wall mount bracket and the screws are not included.*

To use the stand

Your TCL Roku TV comes without the stands attached so that you can choose to use the stands or mount your TV to a wall using a wall mount (sold separately). If you want to mount your TV to the wall, don't attach the stand legs.

A – Place the TV face down on a soft, cushioned surface on a table. The bag the TV was packed in makes a good cushion. Position the TV so that the stand, when attached, will hang over the edge of the table.

B – Align the stands with the screw holes located on the TV stand column:

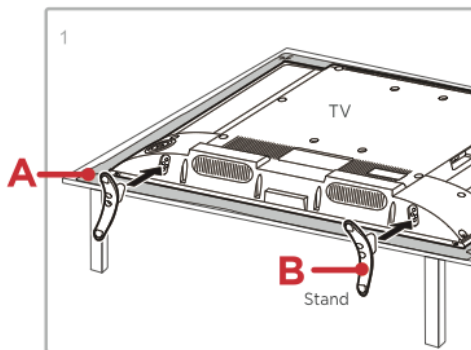

C – Secure stands to the TV with the four (4) screws.

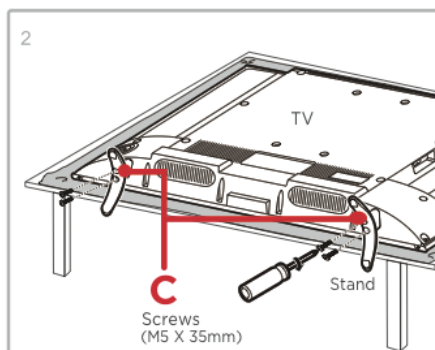

Note: Store the stand and stand screws in a safe place in case you decide to use the stand in the future.

Cable Management

There are three slots on the back of the machine. Insert the cable clip into one of the slot to help you manage your cables!

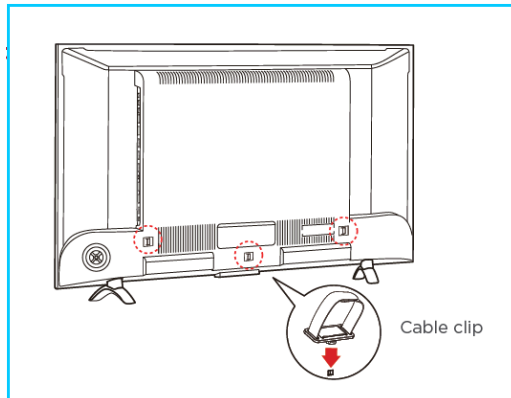

Connect your TCL Roku TV

This section explains how to connect your devices to your TV.

Connecting an antenna, cable, or satellite box

If you are using an antenna, CATV cable without a set-top box, or a cable or satellite box that has only an antenna output, connect a 75-ohm coaxial cable (not provided) from the device to the ANT/CABLE input on the TV.

Tip: If you are using an antenna with a 300 ohm twin-lead cable, you need to use a 300-75 ohm adapter (not provided) to adapt the cable to a connection that is compatible with the TV's antenna input.

Tip: If you receive your TV stations through a set top box from a cable or satellite TV provider, connect it to the TV using the best connection method available. From most to least desirable:

- **HDMI® input** – Digital HD and SD video
- **AV input** – analog SD video
- **Antenna input** – analog SD video using NTSC



Connecting a component with a composite AV video cable

If the best connection available on your component is AV or composite video output, connect it to the TV using a composite AV cable (not provided). Composite AV cables typically have three RCA-type plugs on each end, color coded as follows:

- Yellow: Video
- Red: Audio, right channel
- White or black: Audio, left channel

Connect each plug to the corresponding connector on the component and on the TV.

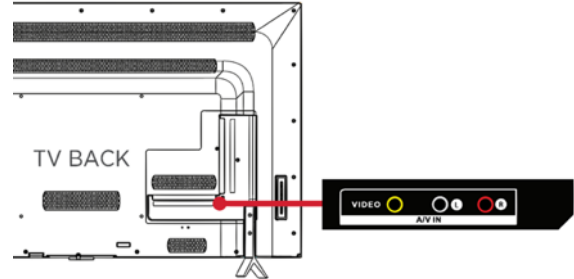

Connecting a component with an HDMI® cable

If possible, connect your devices using HDMI® cables (not provided). They help to provide the best video quality and also carry audio signals, so that only one cable is needed. For better picture quality, we recommend that you use cables designated as High Speed (Category 2) HDMI® cables.

Tip: You might need to configure the component to send its signal through its HDMI® connector.

The connector labeled **HDMI IN (ARC)** has the additional ability to use the audio return channel to send digital audio to a receiver or sound bar, as explained in [“Select models also have an audio line out”](#) connection that is not affected by TV volume or mute settings and does not disable the TV speakers. Use this connection when you want to use your amplifier or sound bar to control the TV volume. To turn off the TV’s built-in speakers, in the **Home** screen menu, navigate to **Settings >**

Audio > TV speakers and change the setting.

Connecting an AV receiver or digital sound bar” on page 9.

Connecting headphones or an analog sound bar

You can connect headphones or an analog sound bar (not provided) to the TV’s headphone jack.

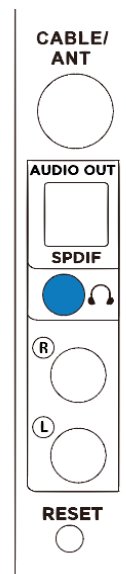

Tip: Inserting a plug in the headphone jack disables the sound from the TV's built-in speakers.

Warning: Loud noise can damage your hearing. When using headphones, use the lowest volume setting on your headphones that still lets you hear the sound.

Select models also have an audio line out connection that is not affected by TV volume or mute settings and does not disable the TV speakers. Use this connection when you want to use your amplifier or sound bar to control the TV volume. To turn off the TV's built-in speakers, in the **Home** screen menu, navigate to **Settings > Audio > TV speakers** and change the setting.

Connecting an AV receiver or digital sound bar

You can enjoy Dolby Digital multichannel sound from your TV if you connect a digital amplifier or sound bar (not provided) in either of two ways:

- **Digital optical audio out (S/PDIF)** – Connect a TOSLINK optical cable (not provided) from the TV to the Optical input on your receiver or sound bar.
- **HDMI[®] ARC** – Connect an HDMI[®] cable (not provided) from the HDMI (ARC) connector to the HDMI[®] input on your receiver or sound bar. This connection uses the Audio Return Channel (ARC) feature of the HDMI[®] specification to output sound from the TV to a compatible device. To use this feature, you must configure the TV to enable HDMI[®] ARC, as explained in "[Enabling HDMI[®] ARC](#)" on page 69.



Preparing for Internet connectivity

If you want to connect your TV to the Internet to watch streaming content, you can choose either a wireless or a wired connection.

- **Wireless connection** – To use a wireless connection, make sure you know the name (SSID) and password you use to connect to your wireless modem/router or wireless access point.
- **Wired connection** – To use a wired connection, plug your Ethernet cable into the RJ-45 jack on the back of the TV. The wired connection supports both 10 and 100 Base-T Ethernet

For wireless operation, the TV connects through a built-in wireless LAN adapter. The TV does not support the use of a USB network adapter.

Note: We recommend that your wireless connection support the IEEE 802.11n specification for the best experience.

AC power

Plug your TV into a power outlet. You can tell that the TV has power because the status light on the front of the TV lights up.

“[Status light](#)” on page [32](#) explains how the status indicator shows what is happening with the TV.

Remote control batteries

Open the back of your Roku TV remote control and insert the included batteries, observing the proper orientation as indicated in the battery compartment. Reattach the back cover.

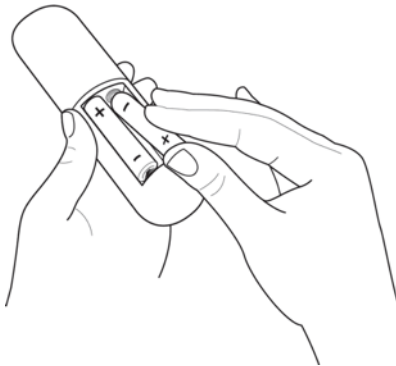

Roku TV Remote control

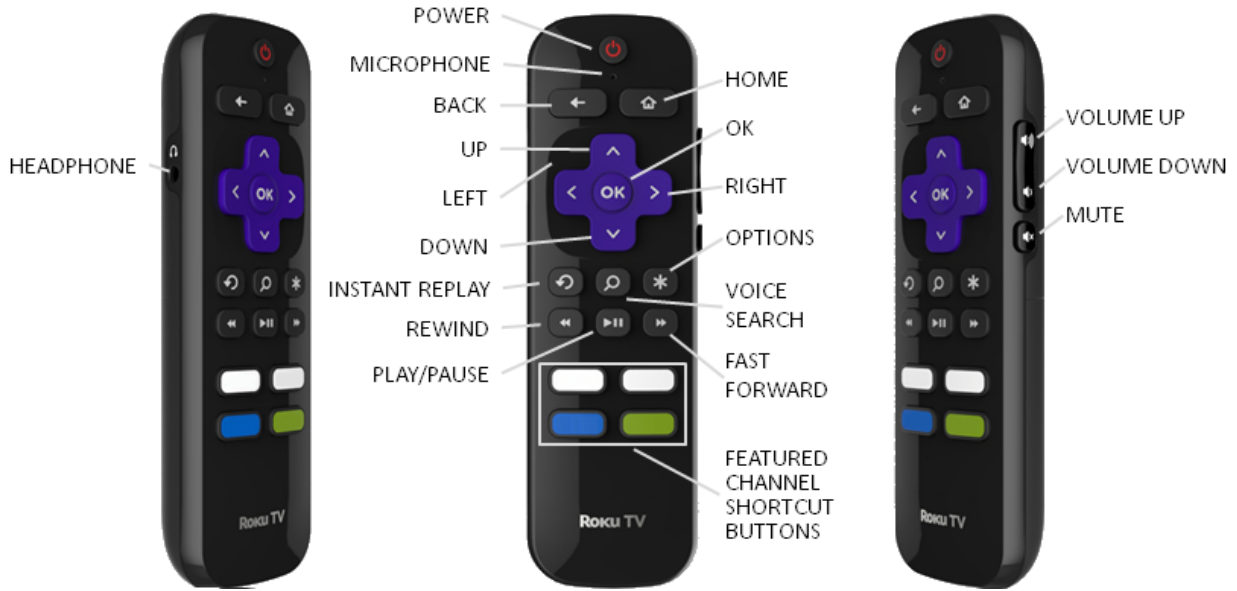

Roku TV Enhanced remote control with Voice Search

Getting around

You've already done a bit of navigating with the remote control when you completed the Guided Setup and when you set up Antenna TV. This section explains how to use the remote control for everyday TV use.



POWER









If the TV is in Standby mode, turns power on.
If the TV is on, puts TV in Standby mode.



BACK

The action depends on what you are doing with the TV:

- **Menu:** Goes back to previous menu/screen.
- **Home screen tile:** Moves highlight back to the **Home** menu option.
- **Watching Antenna TV or a TV input:** Returns to the screen from which the input was selected.
- **Playing streaming content:** Stops playing stream and returns to the previous menu or screen.
- **Browsing streaming content:** Goes to the previous level in the content tree.

	HOME	Immediately returns to the Home screen menu.
	UP	Moves the highlight up one item. Changes channel up while watching TV.
	DOWN	Moves the highlight down one item. Changes channel down while watching TV.
	LEFT	Moves the highlight left, if possible (if a < hint appears). When watching TV, displays your channel list. When playing most streaming videos, skips backward in the video.
	RIGHT	Moves the highlight to the right, if possible (if a > hint appears). When watching TV with the channel list displayed, dismisses the channel list. When playing most streaming videos, skips forward in the video.
	OK	Selects the highlighted option. When watching TV, this button displays information for the current TV program.
	INSTANT REPLAY	When playing streaming video that supports this feature, jumps back a few seconds with each press and resumes playing. In some channels, if Closed captioning is set to Instant Replay , captions are displayed during the duration of the jump back period only. When watching broadcast TV, jumps to previous channel. When using an on-screen keyboard, backspaces in the text you are entering.
	VOICE SEARCH	Displays a Voice Search banner prompting you to say the name of a movie, TV show, actor, or director to search.
	OPTIONS	Displays an Options menu, but only when the Options * hint in the upper right corner of the screen is not dimmed. The menu you see varies depending on what you are doing with the TV. Also, in most cases, pressing * while video is playing displays an Options menu over part of the screen where you can adjust various picture and sound settings.



REWIND

When playing streaming video that supports this feature:

- First press rewinds at 1x speed.
- Second press rewinds at 2x speed.
- Third press rewinds at 3x speed.
- Subsequent presses cycle through 1x, 2x, and 3x rewind speed.

When playing streaming audio, jumps to the previous track/selection.

When any menu, tile, or channel in the channel list is highlighted, jumps up one page.

When using a virtual keyboard, jumps to the character at the top of the current column.



PLAY/ PAUSE

When playing streaming content, alternately pauses and plays the content.



FAST FORWARD

When playing streaming video that supports this feature:

- First press fast forwards at 1x speed.
- Second press fast forwards at 2x speed.
- Third press fast forwards at 3x speed.
- Subsequent presses cycle through 1x, 2x, and 3x fast forward speed.

When playing streaming audio, jumps to the next track/selection.

When any menu, tile, or channel in the channel list is highlighted, jumps down one page.

When using a virtual keyboard, jumps to the character at the bottom of the current column.



VOLUME UP

Turns volume up one setting with each press. Press and hold to turn volume up rapidly. A volume indicator shows the volume level while you are adjusting the volume and for a few seconds afterward.

Note: *If the TV is muted, pressing **VOLUME UP** unmutes the sound.*



VOLUME DOWN

Turns volume down one setting with each press. Press and hold to turn volume down rapidly. A volume indicator shows the volume level while you are adjusting the volume and for a few seconds afterward.

Note: *If the TV is muted, pressing **VOUME DOWN** does not unmute the sound.*



MUTE

Mutes and unmutes the TV sound. A volume indicator shows the current volume level and a mute icon when you press **MUTE** and for a few seconds afterward. If **Closed captioning** is set to **When Mute**, captions are displayed while the TV is muted.

DEDICATED

FEATURED CHANNEL SHORTCUT

Dedicated buttons show the logo of a featured streaming content provider. Pressing a button turns the TV on (if the TV is not already on), and if the TV is operating in connected to the Internet, performs one of the following actions:

DEDICATED

- Displays the streaming channel's main page if you have already added the channel to your **Home** screen.
- Displays the streaming channel's sign-up page if you have not already added the channel so that you can agree to any terms and fees for the service.

DEDICATED

DEDICATED

Guided Setup

With the preliminaries out of the way, it's time to turn on your TCL• Roku TV. As the TV starts for the first time, it leads you through Guided Setup, which configures the TV before you start to use it.

During Guided Setup, you'll:

- Answer a few questions
- Provide network connection information
- Get a software update
- Link your TV to your Roku account.
- Connect devices such as a DVD player, game console, or cable box.

Note: *Guided Setup only runs the first time you turn on your TV. If you need to run Guided Setup again, you'll have to perform a factory reset, as explained in [“Factory reset everything”](#) on page [71](#).*

Starting Guided Setup

To start the Guided Setup, press the **POWER** button on the remote control to turn on your TV.

When you first turn on your TV, it will take a few seconds to get itself ready. You'll notice the following things happening:

1. The status light blinks every time the TV is busy doing something; in this case it's powering up and getting ready for you.
2. The power-on screen appears and the status light blinks slowly for a few more seconds. The power-on screen displays the TCL• Roku TV logo while the TV starts up.

3. After a few seconds, Guided Setup starts:



4. A few moments after the **Let's get started screen** appears, Guided Setup starts the pairing process for the Enhanced Remote Control with Voice Search. If the remote control does not pair automatically, follow the instructions on the screen to complete the pairing process.
5. Press the **UP** or **DOWN** button on the remote control to highlight your preferred language.

Setting up your TV

With the first Guided Setup screen on your TV, follow these steps to set it up:

1. After selecting a language, press **OK** or the **RIGHT** arrow on the remote control to go to the next screen:

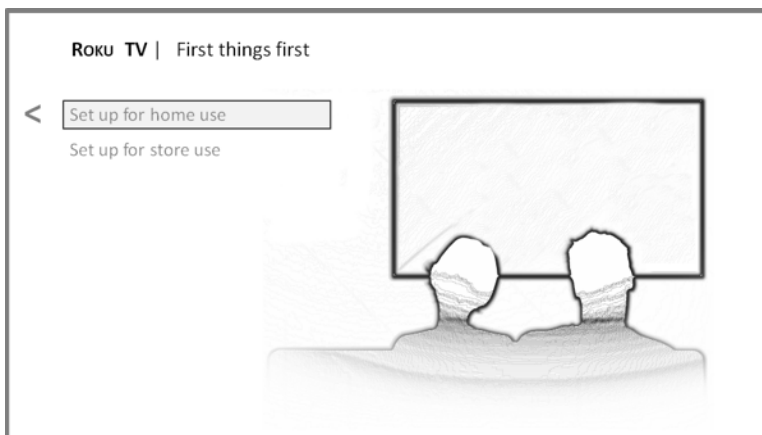

2. Press **OK** to select **Set up for home use**. Home mode is the right choice for enjoying your TV at home. It provides energy saving options as well as access to all features of the TV.

Note: Store mode configures the TV for retail display and is not recommended for any other use. In store mode, some features of the TV are missing or limited. To switch from one mode to the other, you have to perform a factory reset as explained in [“Factory reset everything”](#) on page [71](#), and then repeat Guided Setup.

After you select **Set up for home use**, the TV prompts you to select the way you want to connect to the Internet.

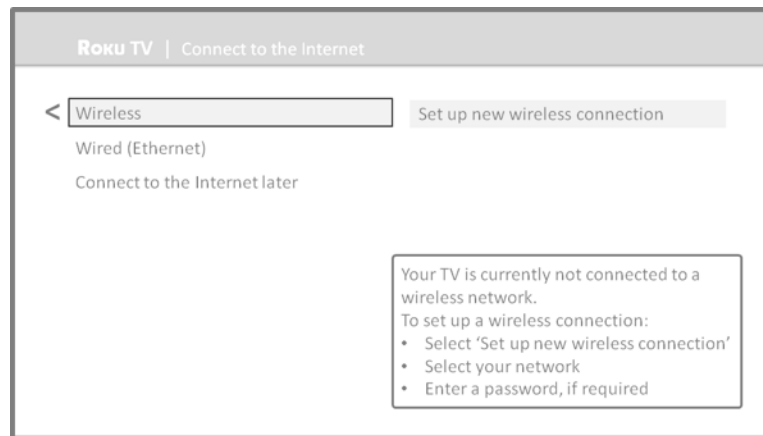

3. Make a selection:

- **Wireless connection** – Highlight **Set up new wireless connection** and press **OK**. The TV prompts you through wireless setup. Go to Step 4 for help with the process.
- **Wired connection** – Highlight **Connect to wired network** and press **OK**. The TV immediately attempts to connect to your wired network, your local network, and then the Internet. Go to Step 8 to continue with Guided Setup.
- **Connect to the Internet later** – If you're unable to connect to the Internet, that's OK. You can skip this step and use the TV to watch broadcasts, play games, and watch DVDs. If you want to connect later, it's easy. We'll show you how in [“Benefits of connecting”](#) on page [25](#).

Note: If you decide not to connect, Guided Setup skips ahead to setting up the devices that you've connected to your TV. See [“Non-connected TCL• Roku TV Home screen”](#) on page [24](#) to get started using your non-connected TV.

Note: Some networks, such as those often found in dorm rooms, hotels, and other public places, may require you to read and agree to terms, enter a code, or provide identifying information before letting you connect to the Internet. If the Roku TV detects that you are connecting to such a network, it prompts you through the connection process using your compatible smartphone or tablet to provide the needed information. For more information, see [“Using your TV in a hotel or dorm room”](#) on page [36](#).

4. After you select **Set up new wireless connection**, the TV scans for the wireless networks within range and displays them in order, with the strongest signals first. In addition to your own wireless signal, the TV might pick up signals from your neighbors.

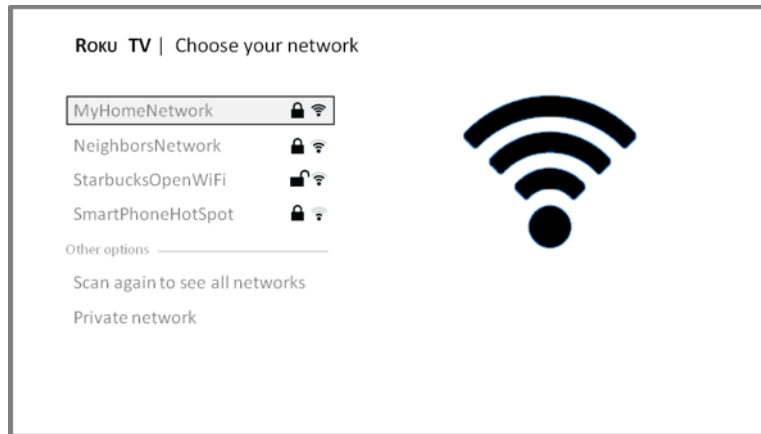

5. Press the **UP** or **DOWN** arrows to highlight the name of your wireless network, and then press **OK** to select it.

Other options:

- **Scan again / Scan again to see all networks** – This option depends on the number of wireless networks within range.
 - **Scan again** appears if the list already shows all available wireless networks within range. If you don't see your wireless network name in the list, you might need to adjust the location of your wireless router or the TV, turn on your router, or make other changes. When everything is ready, select **Scan again** to see if your network name now appears in the list.
 - **Scan again to see all networks** appears if there are more wireless networks than the strongest ones it initially listed. If you don't see your wireless network name in the list, this option displays the complete list. If you still don't see your network name, you might have your router configured to provide wireless service as a "private network."

Note: *Highlighting either of these options displays an informational panel with the unique media access control (MAC) address of your Roku TV. You will need the MAC address if your wireless router is configured to use MAC address filtering.*

- **Private network** – If your wireless network name is hidden, it won't appear in the list. Select **Private network** to display an on-screen keyboard, and use it to enter your network name. Unless you changed the factory-set network name, you can find the name (also called SSID) on a label on the router.
6. If you select a wireless network that is password-protected, an on-screen keyboard appears. Use the keyboard to enter the network password.

Tip: Wireless networks that are password-protected display a “padlock” icon adjacent to the name. This icon enables you to know that you are going to be prompted to enter a password after you select that network.

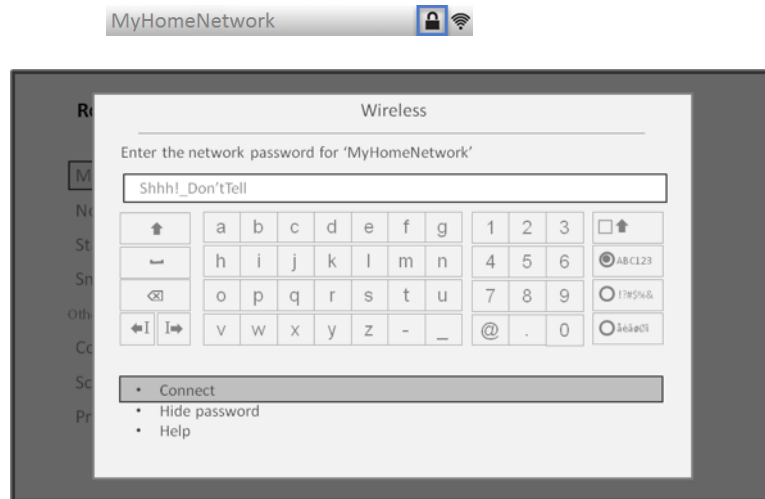

7. After you submit your wireless network password, the TV displays progress messages as it connects to your wireless network, your local network, and the Internet.
8. Your TV needs to know the local time zone so that it can correctly display time information about the program you are currently watching. If the TV is unable to automatically determine the local time zone, it prompts you to choose your time zone from a list. Use the **UP** and **DOWN** arrows to highlight your time zone, and then press **OK**.

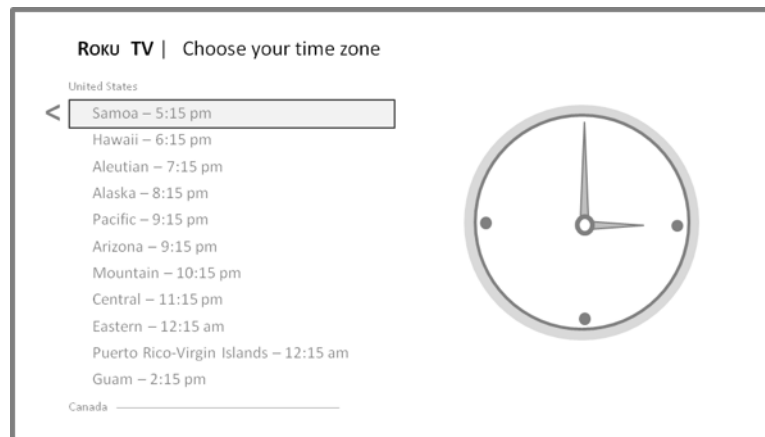

9. As soon as the TV is able to connect to the Internet, it may need to download and install its first software update, and then restart.

Tip: Your TV automatically checks for updates periodically. These updates provide new features and improve your overall experience with the TV. After an update, you might notice that some options have moved, and that there are new options or features. This User Guide

describes version 7.0. To determine your current Roku TV software version, go to **Settings > System > About** after you complete Guided Setup.

You can download an updated User Guide that matches your Roku TV software version from the TCL web site at:

<http://www.tclusa.com/support/>

After the TV restarts, it displays the **Activation** screen:

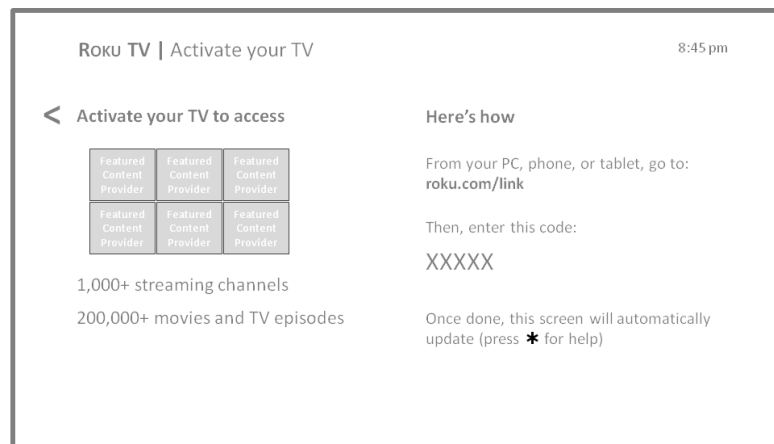

Note: A paid subscription or other payments may be required for some channels. Channel availability is subject to change and varies by country. Not all content is available in countries or regions where Roku products are sold.

10. Using a compatible computer, tablet, or smartphone with an Internet connection, go to the web address displayed on the screen and enter the code that appears on your screen.

After you log in or create your Roku account, the link page suggests that you select some streaming channels. After you confirm your selections, the TV gets an acknowledgement, and then adds your preexisting and newly-selected streaming channels to your Roku TV. This process is automatic and takes a few moments—a little longer if you already have a lot of streaming channels to add.

Tip: Streaming channels from all Roku devices associated with your account are

Why do I need a Roku Account?

You need a Roku Channel Store account for several reasons.

- It links you, your Roku TV and your other Roku devices to the Roku Channel Store and billing service.
- Streaming content providers know that it's OK to send content you request to your Roku TV.
- Roku can automatically send updates to your device.

Important: It doesn't cost anything to use and maintain your Roku Channel Store account (other than the cost of the TV and Internet access). Your Roku TV is packed with hundreds of free channels. Adding a payment method now lets you easily rent or buy movies on demand, or try popular subscription or transaction-based streaming channels.

synchronized periodically, so all of your Roku devices have the same streaming channels (subject to compatibility with the device).

After it adds your selected streaming channels, the TV helps you set up the devices that you're connecting to it, such as a cable box, Blu-ray player, or game console:

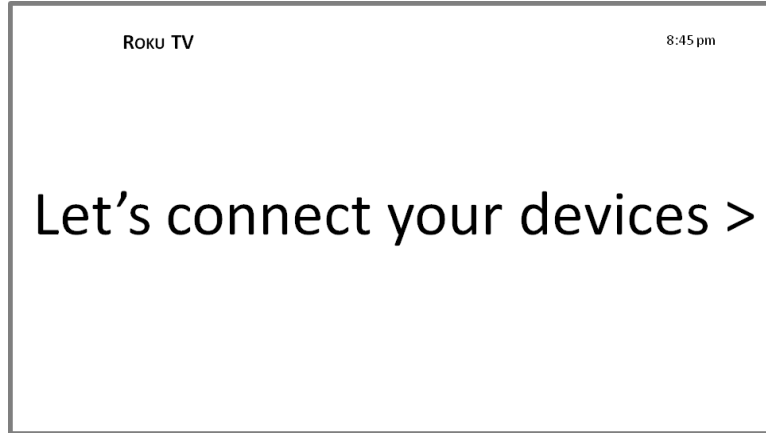

11. Press the **OK** or **RIGHT** arrow to proceed:

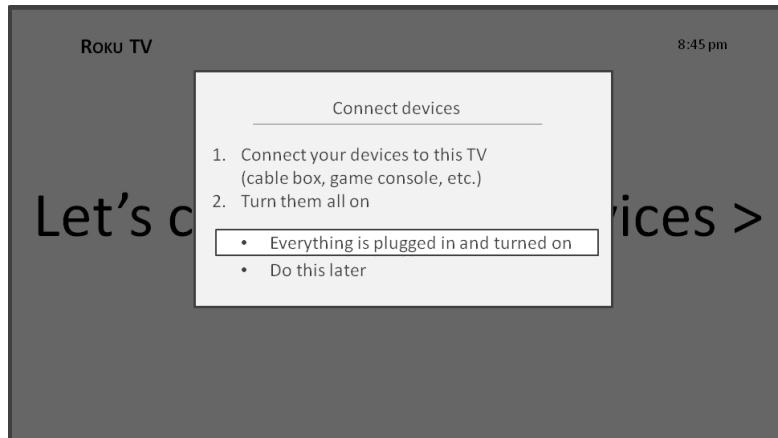

12. Connect all the devices you plan to use with your TV, turn them all on, and then select **Everything is plugged in and turned on**. The TV now takes you step by step through each of its inputs and asks what kind of device you have connected. On each input that has a connected and active device, you can see its picture and hear its sound.

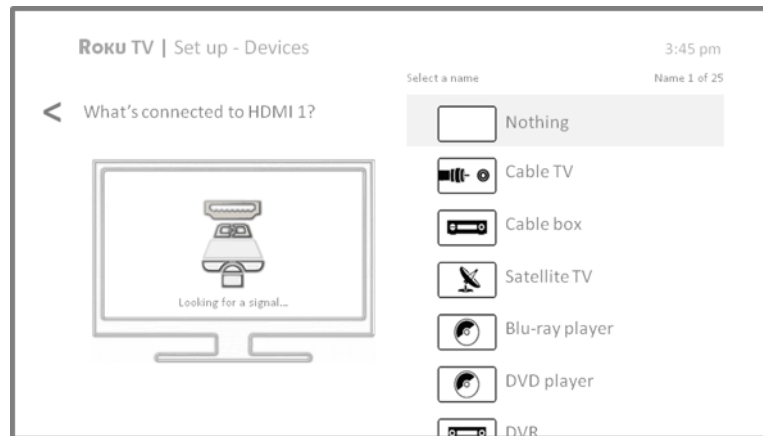

13. Press the **UP** or **DOWN** arrows to highlight the label you want to associate with the input, and then press **OK** to move on to the next input.

You're done with Guided Setup.



Note: Some Roku TVs, depending on where you live and other factors, show you an introductory video filled with some great hints and tips. If you're not interested in viewing this video, press  on the remote control to exit to the Roku TV **Home** screen.

When you finish Guided Setup, and whenever you press  on the remote control, the **Home** screen greets you.

From here, you can explore everything your TV has to offer. Press the arrow buttons to move around, and press **OK** to select a highlighted item. We've designed the TV to encourage you to explore, and you can probably figure out most of the capabilities and settings on your own. If you have any questions or difficulties, you can find answers and solutions in this guide.

If you find yourself a long way from the **Home** screen, you can always get back right away by pressing one button: 🏠.

Connected TCL• Roku TV Home screen

Here is a typical **Home** screen from a Roku TV that's connected to the Internet and linked to a Roku account.

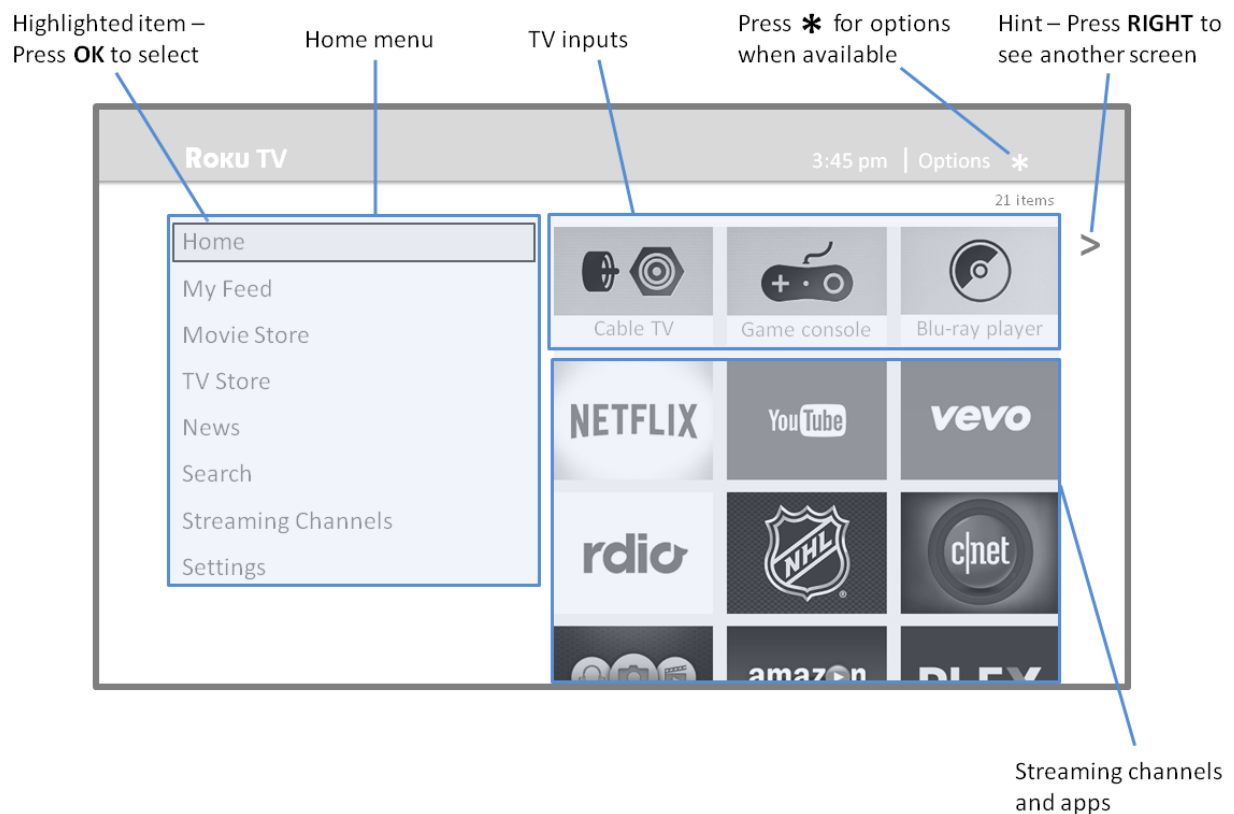

Personalize your Home screen

You can do a lot to personalize your **Home** screen and make it just right for you and your family:

- Add streaming channels by using the **Streaming Channels** menu option to browse the Roku Channel Store.
- Remove a tile by highlighting it and pressing *****. Then highlight **Remove input** or **Remove channel** and press **OK**.
- Reposition a tile by highlighting it and pressing *****. Then highlight **Move input** or **Move channel** and press **OK**. Use the arrow buttons to move the tile, and then press **OK** to lock it in its new location.

- Rename a TV input tile by highlighting it and pressing *****. Then highlight **Rename input** and press **OK**. Highlight a new name in the list, and then press **OK** to assign that name to the tile.
- Change the screen theme by going to **Settings > Themes** to find and pick one to suit your mood.
- Hide Movie Store, TV Store, or News, (US models only) as explained in [“Blocking Movie Store, TV Store, and News”](#) on page .

Non-connected TCL• Roku TV Home screen

Here is a typical **Home** screen from a Roku TV that is not connected to the Internet.

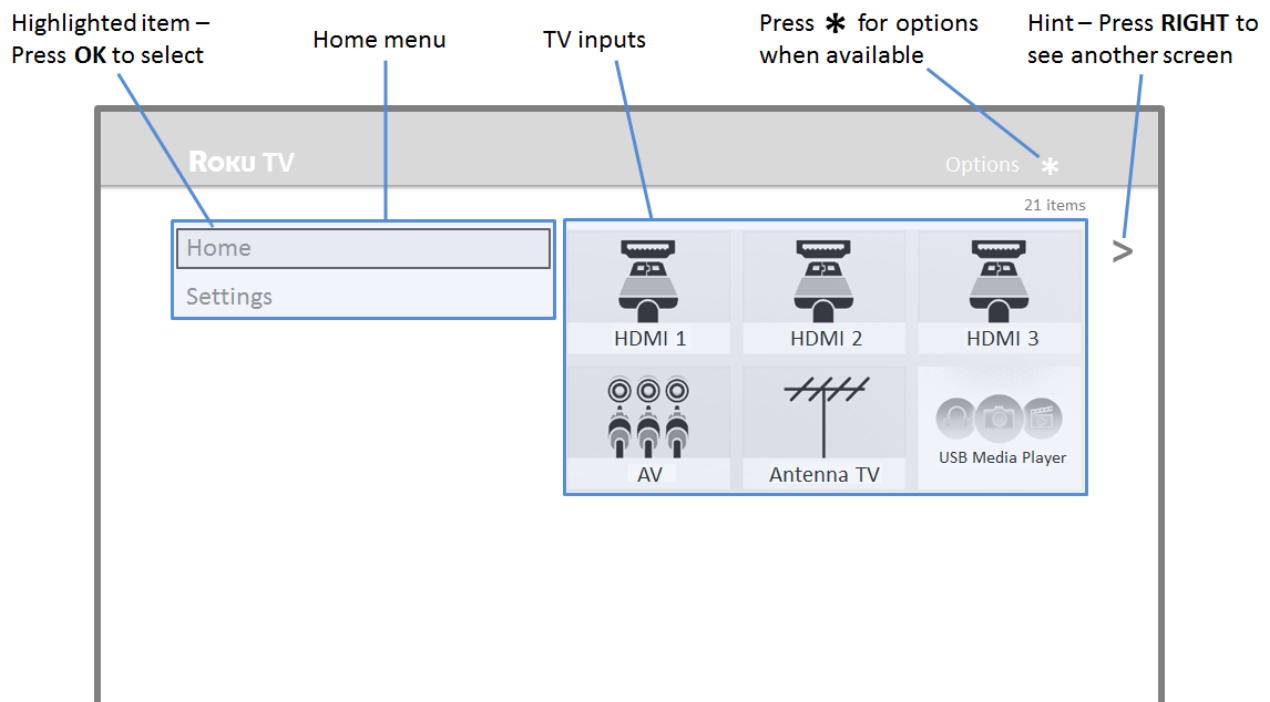

Personalize your Home screen

You can do a lot to personalize your **Home** screen and make it just right for you and your family:

- Remove a tile by highlighting it and pressing *****. Then highlight **Remove input** and press **OK**.
- Reposition a tile by highlighting it and pressing *****. Then highlight **Move input** and press **OK**. Use the arrow buttons to move the tile, and then press **OK** to lock it in its new location.
- Rename a tile by highlighting it and pressing *****. Then highlight **Rename input** and press **OK**. Highlight a new name in the list, and then press **OK** to assign that name to the tile.
- Add streaming channels by browsing the Roku Channel Store (after connecting the TV to the Internet to add the **Streaming Channels** option to the menu).

Benefits of connecting

Connecting brings out your TCL• Roku TV's full potential!

Make any night a movie night

Thousands of movies to choose from, across all major streaming movie channels like Netflix, Cineplex Store, Crackle, and more*. You'll never run out of something new to watch.

Get in the groove

Stream endless hours of music from free and subscription-based channels like Spotify and VEVO. With almost instant access to thousands of music artists, your favorite beats are just as close as your remote.

Explore your passions

In addition to popular streaming channels like YouTube, NHL, Sky News and Cineplex Store, your Roku TV also offers hundreds of streaming channels to fuel your passions—including fitness, cooking, religion, outdoors, International programming and much more.

Enjoy FREE trials of popular channels

Your TCL• Roku TV comes loaded with special offers, including free trials from popular streaming channels Netflix, Spotify, DailyBurn Fitness, and many more. But remember that you must cancel before the free trial ends to avoid subscription fees.

What is streaming?

Streaming is viewing or listening to video or audio content that is sent over the Internet, or located on a network-connected media server or on a USB device plugged into the TV's USB port.

* A paid subscription or other payments may be required for some channels. Channel availability is subject to change and varies by country. Not all content is available in countries or regions where Roku products are sold.

With streaming, you can buy or rent most programs on demand, when it's convenient for you. When streaming, you can play, pause, rewind, and fast forward whatever you are watching. You can also replay the last few seconds again, or turn on closed captions.

Tip: *Some content cannot be paused or skipped. For example, if you are viewing live programming or a program that is supported by ads, you generally are not allowed to skip the ads.*

Your Roku TV lets you choose from thousands of streaming channels that offer a huge selection of entertainment:

- Thousands of movies and TV episodes
- Unlimited music, live and on-demand
- Tons of live and on-demand sports
- Commercial-free kids programming
- International programming in 22 languages
- 24x7 news and in-depth news commentary

Many streaming channels are free. Some streaming channels, like Cineplex and Amazon Instant Video, let you purchase or rent the latest movie releases or popular TV series. Some channels such as Netflix or Spotify charge a monthly subscription fee and others are free if you subscribe to a companion service through your cable or satellite provider. For example, HBO subscribers with participating broadcast TV provider accounts can add the HBO Go channel and watch it for free.

If you have an existing subscription to a service like Netflix or Spotify, you can just sign in with your existing user name and password.

To play streaming content that is available on the Internet, you add streaming channels to your **Home** screen. To add a streaming channel to your **Home** screen, use the **Streaming Channels** option on the **Home** screen menu to go to the Roku Channel Store, and then select the streaming channel you want to add. The streaming channel is then added to your **Home** screen, and you can watch it at any time.

For more information on using the Roku Channel Store feature, see "[Using the Roku Channel Store](#)" on page [49](#).

Note: *A paid subscription or other payments may be required for some channels. Channel availability is subject to change and varies by country. Not all content is available in countries or regions where Roku products are sold.*

But what if I didn't connect my TCL• Roku TV?

What if you went through Guided Setup and chose **Connect to the Internet later**? No worries. Your TCL• Roku TV makes it easy to connect whenever you want. As you move around the **Home** screen, you'll see several places where you can start the connection process. For example:

- Now and then you'll see a message appear on the panel to the right of the **Home** screen offering a **Connect Now** option. Simply highlight and select the **Connect Now** option to get started.
- Use the **Connect and activate now** option in the **Settings** menu. From the **Home** screen menu, select **Settings**, then **Network**, and then **Connect and activate now**.
- If you want to start over from the beginning, use the **Settings** menu to do a **Factory reset**, and then go through Guided Setup again. This time, choose your home network when prompted.

Regardless of how you connect, the process is the same. If you need details, see "[Setting up your TV](#)" on page [16](#).

Setting up Antenna TV

Despite all of the entertainment possibilities of your Roku TV, you may also want to watch broadcast TV. You can watch broadcast TV in much the same way you watch other entertainment choices. You select a tile—the **Antenna TV** tile—from the **Home** screen.

The first time you select the **Antenna TV** tile, you have to set up the TV tuner. Setting up the TV tuner scans for active channels and adds them to your broadcast TV channel list.

Why do I have to set up the TV tuner?

You might be asking, “Why is this step necessary?” Good question.

Not everyone needs to use the TV tuner. For example, you might have a set top box provided by a cable or satellite company that receives all of your channels. Most of these set top boxes use an HDMI[®] connection.

More and more people are watching only streaming TV and do not have a TV antenna or cable/satellite service. If you don’t need the TV tuner, you can bypass setting it up and instead remove it from the **Home** screen as explained in [“Remove unwanted tiles”](#) on page [53](#).

When you set up Antenna TV, the TV scans the signals on its antenna input for channels with a good signal, and adds those to the channel list, skipping dead channels and channels with a very weak signal.

The TV will, however, let you add two analog channels, even if they have no signal. You might need to add these channels if you have an older set top box, VCR, or game console that can only output a signal on analog channel 3 or 4. These are the only channels that can be added regardless of whether they have a good signal. Typically, you’ll only need one of these channels, but both are provided to make setup simpler. You can hide the one you don’t want as explained in [“Edit broadcast TV channel lineup”](#) on page [52](#).

How do I set up the TV tuner?

Setting up the TV tuner is easy—your TV does most of the work. You just have to answer a couple of questions.

1. Make sure your antenna (sold separately) or TV cable is connected to the TV’s **ANT/CABLE** input.

2. On the **Home** screen, select the **Antenna TV** tile.
3. Read the simple on-screen instructions and select **Start finding channels**.



4. If prompted, select your time zone. You'll only need to do this if the TV can't figure out your time zone from your Internet connection.

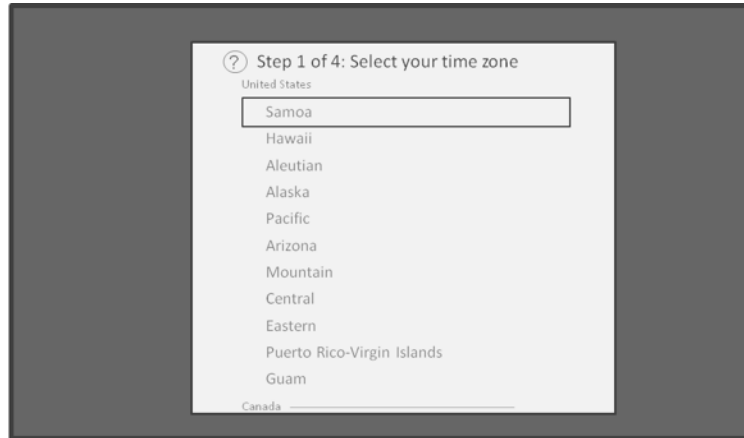

Why does the TV need my time zone?

The TV needs to know your time zone so that it can correctly display time information about the program you are currently watching.

5. When prompted, select whether to add analog channels 3 and 4 (to enable you to connect older set top boxes, VCRs, or game consoles).

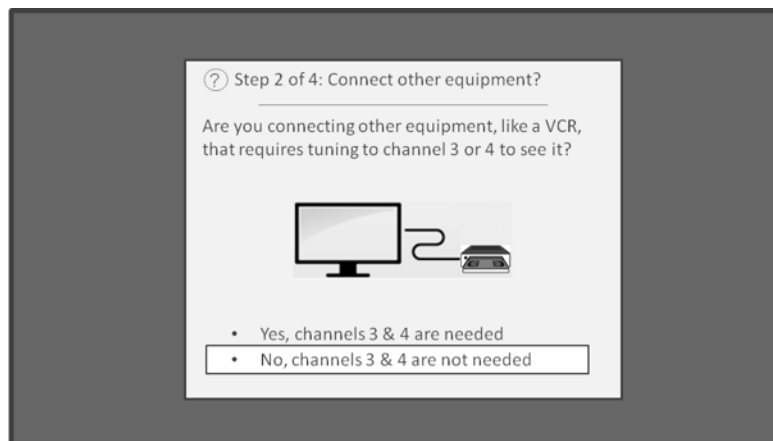

6. Wait while your TV scans for broadcast (antenna TV) stations...

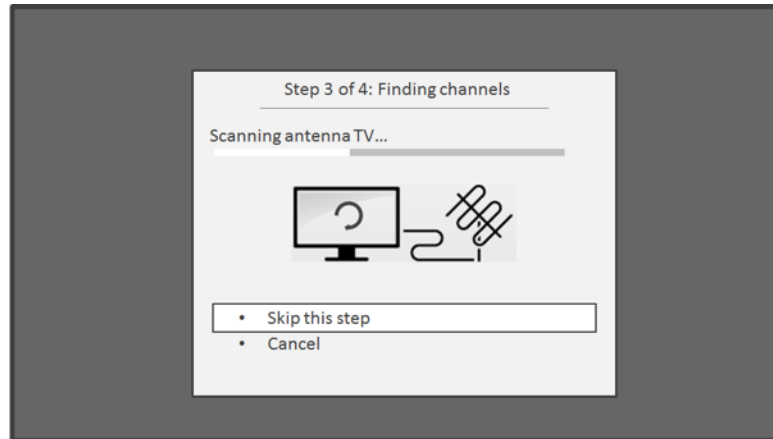

... and then cable TV channels.

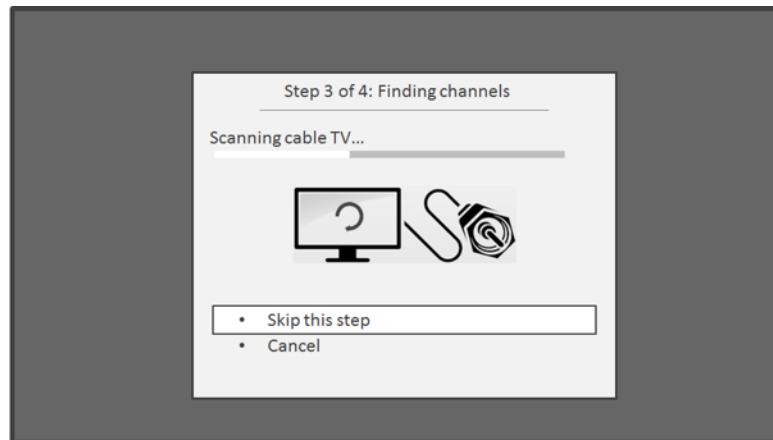

Tip: Cable TV channels are channels from a cable TV provider that you can receive by connecting their cable directly to your TV (unscrambled NTSC, ATSC, and QAM channels, if you're the kind of person who is interested in the details). In many cases, your cable provider probably requires you to use their set-top box and connect it to a different input, and then use the set-top box to tune your cable stations. In that case, you can skip scanning for cable channels.

7. When the channel scans finish, the TV shows the number of channels it added.

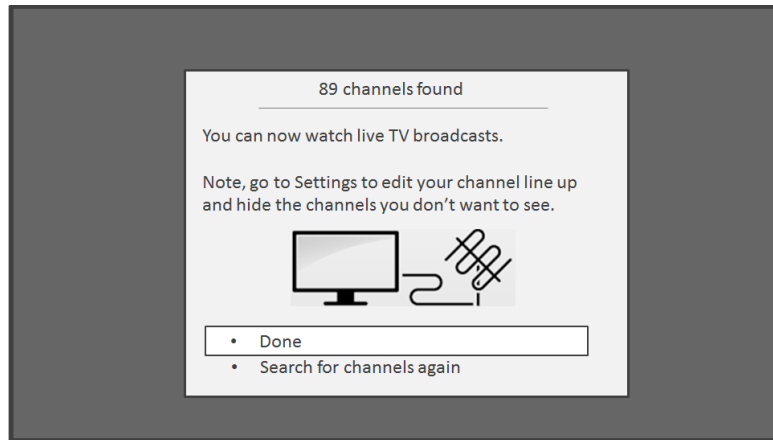

Scanning for channels can take several minutes.

Tip: Repeat the channel scan from time to time to make sure you are receiving all of the latest channels. Broadcasters add and remove channels, move channels to different parts of the spectrum, and change the power levels of their channels periodically.

Note: You'll have to repeat the channel scan if you remove the **Antenna TV** tile from the **Home** screen or perform a factory reset. To repeat the channel scan at any time, go to **Settings > TV inputs > Antenna TV > Scan again for channels > Start finding channels**. Your antenna reception and picture quality depend on the position of your antenna and on your location relative to the antennas of broadcasters in your area.

Now, you're ready to watch broadcast TV! While you're watching, try the following:

- Press the **UP** and **DOWN** arrows to change channels.
- Press the **LEFT** arrow to display the channel list and then use the **UP** and **DOWN** arrows to select a channel to watch. Or press **REWIND** or **FAST FORWARD** to jump through the channel list a page at a time.
- Press **OK** to display information about the current program.
- Press ↶ to switch to the previously tuned channel.
- Press * to see options for picture and sound settings.

Note: If ↶ is not available on your remote control, you can use ↶ on the Roku App or the Jump Back button on a universal remote. For more information, see "[Other devices](#)" on page [75](#).

"[Roku TV Remote](#)" on page [11](#) has more information on using the remote control buttons while watching TV.

Using your TCL• Roku TV

This section provides information on using the day-to-day features of your TCL• Roku TV.

Status light

Your TV has a single status light on the front panel. It goes on and off and blinks in different ways depending on the status of the TV, as shown in the following table:

TV condition	Status indicator	Meaning
On (screen is active)	Off	Screen is communicating that TV is on.
Screensaver (screen is active)	Off	Screen is communicating that TV is on.
Off (no power)	Off	TV is not connected to power.
Off (standby)	On	TV is connected to power and is ready to use.
Starting up from off state	Slow pulsing blink until startup completes	TV is doing something.
On (receiving update from USB)	Slow pulsing blink until update completes	TV is doing something.
Remote control command received	Dims on/off once	TV has received your command.
Powering down to standby mode	Slow pulsing blink until the TV reaches standby.	TV is doing something.

Panel buttons

The controls on the TV enable you to perform simple functions, but are not a substitute for the remote control. The joystick-type control on the back of your TV near the lower right side provides the following functions:



- Press in to toggle between power ON and Standby.
- Press up or down to increase/decrease the volume.
- Press left or right to switch inputs.

Standby mode energy savings

When you turn off your TV, it may remain in a higher power mode for a few minutes, after which it goes into a very low power standby mode. If you turn on the TV again before it has entered the very low power mode, it turns on immediately. After the TV goes into the lower power standby mode, it takes a bit longer to start up.

Watching broadcast TV channels

To watch broadcast TV, select the **Antenna TV** tile in the **Home** screen. Your TV remembers the last channel you watched and starts with that channel playing.

Tip: You also can use the buttons on the TV panel to select Antenna TV, as explained in "[Panel buttons](#)" on page [33](#).

Changing channels

To change channels, you can do any of the following:

- Press the **UP** arrow to change to the next higher channel.
- Press the **DOWN** arrow to change to the next lower channel.
- Press the **LEFT** arrow to display the channel list, and then press the **UP** and **DOWN** arrows to move the highlight through the list one channel at a time. Or press **REWIND** and **FAST FORWARD** to move the highlight through the list one page at a time. When you've highlighted

the channel you want to watch, press **OK**. (If you decide you don't want to change channels, press the **RIGHT** arrow or **BACK** button).

- Press ↶ to jump to the previous channel. Press again to return to the channel you were watching before you pressed ↶.

Note: If ↶ is not available on your remote control, you can use ↶ on the Roku App or the **Jump Back** button on a universal remote. For more information, see "[Other devices](#)" on page [75](#).

Viewing program information

To view information about the current program, press **OK**. The TV displays a banner at the bottom of the screen with as much information as is available in the program data stream, as shown in the following example.



Program information banner

Program information, subject to availability within the broadcast information, includes:

- Channel number
- Channel call sign
- Signal strength
- Program title
- Start time, end time, and graph of program length showing current position
- Content rating
- Video resolution (480i, 480p, 720p, 1080i, 1080p, 4K [on UHD TVs only])
- Audio quality (Mono Dolby Digital, Stereo Dolby Digital, 5.1 Dolby Digital, Dolby Digital+)
- Audio features (SAP)
- Closed captioning (CC)
- Current time
- Program description. If the entire description does not fit, press **OK** to expand the size of the banner and see the entire description.

Adjusting settings

Press ***** to display the **Options** menu. Press the **UP** and **DOWN** arrows to highlight an option, and then press the **LEFT** and **RIGHT** arrows to change the setting. “[Adjusting TCL• Roku TV settings](#)” on page [39](#) explains each of the settings in detail.

Switching TV inputs

Switch to a TV input to access the device connected to that input, for example, a Blu-ray player. Switching inputs is as simple as highlighting the input’s tile in the **Home** screen, and pressing **OK**. The video signal on the input, if any, appears on the screen.

Tip: You also can use the buttons on the TV panel to select a TV input, as explained in “[Panel buttons](#)” on page [33](#). “[Customizing your](#)” on page [51](#) explains how to rename and remove inputs.

Auto-detecting devices

Your TV automatically detects when you connect a new device to an HDMI[®] input and turn on its power. The input is automatically added to the **Home** screen if it isn’t already present.

Adjusting audio/video settings

While watching video content on any input, press ***** to display the **Options** menu. Press the **UP** and **DOWN** arrows to highlight an option, and then press the **LEFT** and **RIGHT** arrows to change the setting. “[Adjusting TCL• Roku TV settings](#)” on page [39](#) explains each of the settings in detail.

Playing content from USB storage devices

Your TV has a USB port that can be used to play personal music, video, and photo files from a personal USB flash drive or hard disk. If your TV is connected to the Internet, your **Home** screen has the **Roku Media Player** tile. If your TV has not been connected to the Internet, the **Home** screen has the **USB Media Player** tile.

To use this feature, first make sure your media files are compatible with the Roku/USB Media Player. As of the publication date of this guide, the following media file formats are supported*:

* There are many variants of each of these media formats. Some variants may not play at all or may have issues or inconsistencies during playback.

- **Video** – (H.264/262/265HEVC) in MKV, MP4, and MOV files; VP9 in MKV files
- **Music** – AAC (5.1), MP3, WMA, WAV (PCM), AIFF, FLAC, AC3, and DTS*
- **Photo** – JPG, PNG (up to 16k x 16k pixels), GIF (up to 16k x 16k pixels)

To see the latest list of supported formats, view **Help** in the Media Player.

The Roku/USB Media Player displays supported file types* only, and hides file types it knows it cannot play.

Playing content from local network media servers

If you have connected your TV to a network, it can play personal video, music, and photo files from a media server on your local network. Media servers include personal computers running media server software such as Plex or Windows Media Player, network file storage systems that have built-in media server software, and other devices that implement the specifications of the Digital Living Network Alliance. Some servers do not fully implement the DLNA specification but are UPNP (Universal Plug and Play) compatible. The Roku Media Player will connect to them as well.

Some media servers can convert files into Roku compatible formats. DRM-protected content is not supported.

Using your TV in a hotel or dorm room

Hotels, school dorms, conference facilities, and similar locations with public wireless Internet access often require you to interact with a web page to authenticate your access. These restricted public networks are commonly known as captive portal networks. When you select a network of this type, the TV automatically detects that additional information is needed and prompts you through using another wireless device to supply the requested information.

Tips:

- *Using your Roku TV on a hotel or dorm room network requires wireless availability and use of your network-connected smartphone, tablet, or computer to authenticate access to your account.*
- *Be sure to bring your Roku TV remote control, because the Remote feature of the Roku mobile app may not work when connected to a hotel or dorm room network.*
- *Content might be limited or unavailable if you try to connect outside your home country due to geo-filtering.*

* DTS audio, whether in music or video files, is supported only by pass-through, meaning that the TV cannot directly output the sound of a DTS file, but can pass it through to a DTS-compatible receiver that is connected to the HDMI ARC or S/PDIF connector on the TV.

To connect your TV to the restricted network:

1. Either during Guided Setup or after using the Settings > Network menu to set up a new connection, the TV automatically detects that you are connecting to a restricted network and displays the following prompt:

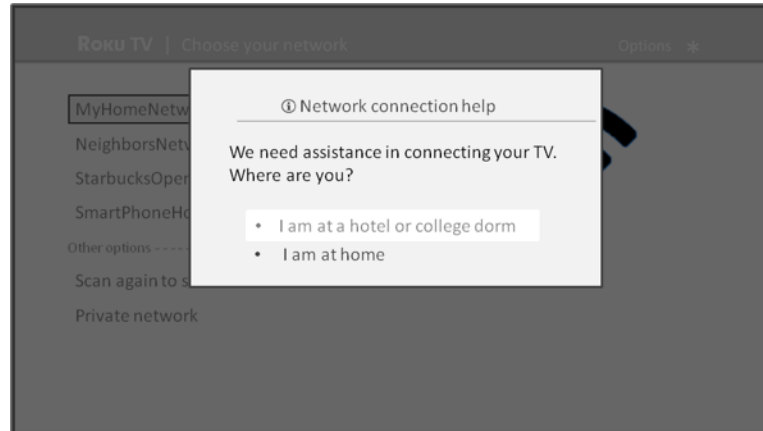

Tip: Your TV can connect to a restricted network only if **Device connect** is enabled in **Settings > System > Advanced system settings**. (**Device connect** is enabled by default, but if you have disabled it, the TV cannot complete the connection.)

Note: **Device connect** is not present if the TV is in non-connected mode.

2. If you selected the correct network, highlight **I am at a hotel or college dorm**, and then press **OK**. The TV prompts you to use your smartphone, tablet, or laptop to complete the connection.

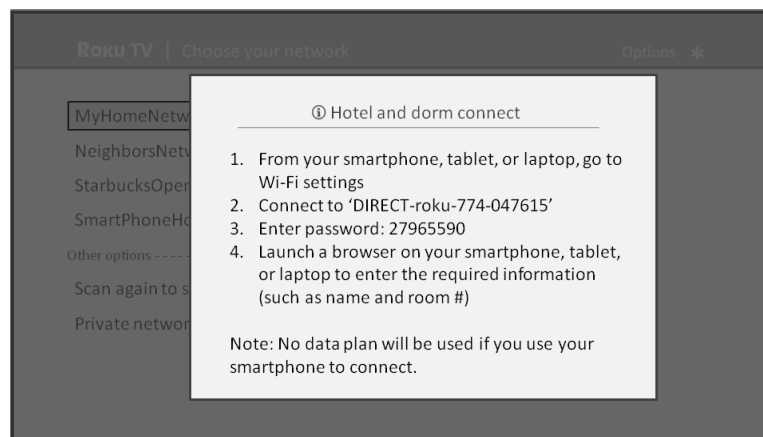

3. Use a phone, tablet, or wireless-enabled computer to detect wireless networks. In most cases, you can simply open the device's Wi-Fi Settings or Network Settings screen to start scanning.

Note: The phone, tablet, or computer must be on the same wireless network to which you are connecting the TV.

4. Connect to the network named on your TV screen. The actual network name varies.

Note: *The previous step connects your smartphone, tablet, or computer directly to the TV. No connection charges apply and the connection does not impact your device's data plan.*

5. The wireless connection process prompts you for a password. Enter the password as shown on the TV screen. The actual password varies.
6. Start the web browser on your smartphone, tablet, or computer. When you attempt to open any web page, the restricted connection will prompt you for whatever information it needs. In most cases, you must agree to terms and conditions, provide identifying information, or enter a password, PIN, or room number to proceed. The information requested depends on the organization that controls the wireless connection.
7. After you enter the requested information, the TV automatically proceeds to complete its connection and resumes normal operation.
8. If the TV prompts you to link to your Roku account, use your smartphone, tablet, or computer to complete the pairing operation and activate your Roku TV.

Adjusting TCL• Roku TV settings

You can adjust most picture and sound settings while you are watching a program by pressing ***** to display the **Options** menu. If you don't find what you need, there are additional picture and sound settings in the **Settings** menu.

In most cases, the changes you make apply only to the input you are using. Antenna TV, each separate HDMI[®] input, and the AV input have their own settings that the TV remembers when you return to that input. The TV also remembers the settings you specify while viewing streaming content.

Settings menu

Use the **Settings** menu to adjust overall TV settings. Press  to go to the **Home** screen, and then navigate to **Settings > TV picture settings**.

You can adjust the following overall TV picture settings from the **Settings screen**:

- **TV brightness** – If the lighting level in your TV room changes, use this setting to help provide a better viewing experience; set to darker for a darker room, and brighter for a brighter room. Choose among **Normal** and four other settings to make the overall picture brighter or darker. So that you don't have to make this type of change for each TV input one at a time, this setting increases or decreases the TV's general brightness across all TV inputs. *This setting is identical to the **TV brightness** setting you can access in the **Options** menu while watching a program.*
- **Settings per input** – This section of options lists each TV input. Select an input to switch to that input. Then press ***** to display the **Options** menu, where you can adjust the input's settings while watching a live picture and listening to the sound from that input.

Tip: *You don't have to go to the **Settings** menu first—you can display an input's **Options** menu and adjust its settings whenever you are watching the input by pressing *****.*

Options menu

The **Options** menu for each TV input provides settings for controlling the appearance of the picture and the quality of the audio.

To view the **Options** menu, press ***** whenever you are watching a TV input or streaming a video. The **Options** menu is a panel that appears over the left side of the screen:

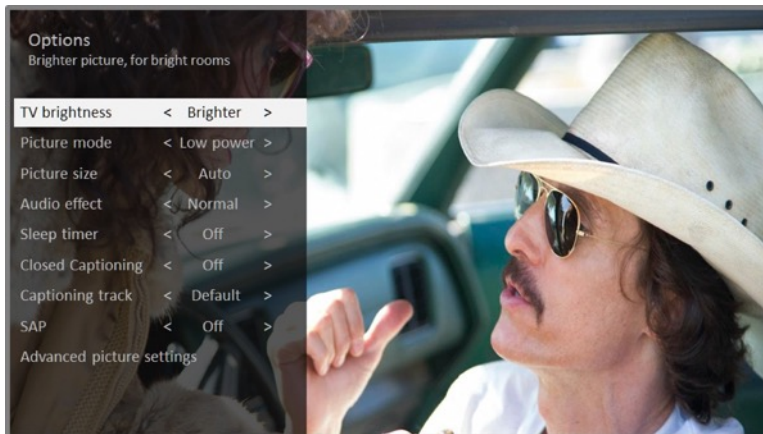

To adjust the settings on the **Options** menu, press the **UP** or **DOWN** arrow to highlight a setting, and then press the **LEFT** or **RIGHT** arrow to change the setting. You'll notice the changes you make right away in picture appearance or audio quality.

Tip: When you highlight a setting, the header text explains the effect of its current value. When you begin to adjust a setting, the other options are hidden so you can see more of the screen. Even though the other settings are hidden, you can move the highlight up or down to adjust the other settings.

Options menu settings

- **TV brightness** – Affects the overall brightness of the picture. *This setting applies across the entire TV; that is, to all TV inputs and is identical to the **TV brightness** setting under **Settings > TV picture settings**.*
- **Picture mode** – Provides picture presets for various viewing preferences. *This setting applies to the currently-selected input only.*
- **Picture size** – Adjusts the aspect ratio of the picture, enabling you to view a picture in its original format, or zoom or stretch it to fill the screen. The **Auto** setting has been found to produce the best picture in most cases.
- **Audio effect** – Adjusts the sound quality output from the TV speakers. *This setting applies across the entire TV; that is, to all TV inputs.* It does not affect the sound quality for headphones, HDMI (ARC), or SPDIF (TOSLINK) connectors.

- **Sleep timer** – Sets a timer that turns off the TV after the specific amount of time. *This setting remains in effect even if you stop watching the current input.*
- **Closed captioning** – Controls when you see captions. *This setting is only offered for Antenna TV, the AV input, and streaming videos. Any set value remains in effect across only these inputs.*
 - **Antenna TV** – Turn captions on or off, or set them to appear only when the TV sound is muted.
 - **AV input** – Turn captions on or off, or set them to appear only when the TV sound is muted.
 - **Streaming video channel** – Turn captions on or off, set them to appear only when the TV sound is muted, or only during instant replay (for streaming content that supports instant replay).

Note: *If the Instant Replay ↺ button is not available on your remote control, you can use ↺ on the Roku App or the **Jump Back** button on a universal remote. For more information, see “[Other devices](#)” on page [75](#). Additional captioning options are provided in the **Captions** screen in **Settings**.*

- **Captioning track** – Selects which caption track to display when Closed Captioning is on. *This setting remains in effect on all inputs that provide captions.*
- **SAP** – Selects whether to play a secondary audio program or multichannel television sound, and which choice to play. *This setting applies only to Antenna TV on digital channels.*

Tip: *To dismiss the **Options** menu, just wait a few seconds without pressing any buttons. Or press ***** again to dismiss the menu immediately.*

Advanced picture settings

The **Advanced picture settings** menu for each TV input provides settings for fine tuning the appearance of the picture. All of the settings in this menu apply only to the currently-selected input.

To use the **Advanced picture settings** menu, first press ***** to display the **Options** menu. Then select **Advanced picture settings**.



To adjust the settings on the **Advanced picture settings** menu, press the **UP** or **DOWN** arrow to highlight a setting, and then press the **LEFT** or **RIGHT** arrow to change the setting. You'll notice the changes you make right away in picture appearance.

Tip: When you highlight a setting, the header text explains the effect of its current value. When you begin to adjust a setting, the other options are hidden so you can see more of the screen. Even though the other settings are hidden, you can move the highlight up or down to adjust the other settings. As soon as you press the **UP** or **DOWN** arrow, the other settings become visible again.

Advanced picture settings menu options

- **Picture mode** – Provides picture presets for various viewing preferences. This setting duplicates the one on the **Options** menu. When you change the **Picture mode**, other picture settings adjust accordingly. For example, setting the **Picture mode** to **Vivid** sets **Brightness**, **Contrast**, **Sharpness**, and other values to produce a very vibrant picture. Setting **Picture mode** to **Movie** changes these same settings to produce a picture suitable for enjoying movies in a darkened room. If you make changes to the individual picture settings—for example, **Contrast**, or **Sharpness**—these settings are saved for the current input *and* the current picture mode. In this way, the HDMI 1 input's **Movie** picture mode can be customized and different than the HDMI 2 input's **Movie** picture mode and Antenna TV's **Movie** picture mode. Use **Reset picture settings**, described below, to return the input's current picture mode to its original values.
- **Dynamic Contrast** – Automatically adjusts the backlight level to achieve the optimum contrast and prevent excessive differences between light and dark areas of the screen. *The **Backlight** option is disabled when **Dynamic Contrast** is enabled.*
- **Backlight** - Adjusts the overall light intensity of the screen.
- **Brightness** – Adjusts the dark level of the black areas of the picture.
- **Contrast** – Adjusts the white level of the light areas of the picture.
- **Sharpness** – Adjusts the sharpness of the edges of objects in the picture.

- **Color** – Adjusts the intensity of colors in the picture. A setting of 0 removes all color and displays a black and white picture.
- **Tint** – Adjusts the color balance from green to red to obtain accurate colors in the picture.
- **Color temperature** – Adjusts the overall colors in the picture from **Normal** to slightly more bluish (**Cool**) to slightly more reddish (**Warm**).
- **Game mode** – Controls whether Game mode is on or off. When **On**, the TV performs less image processing and has less input lag. When **Off**, the TV may perform more image processing and has more input lag, which is less desirable for action games. *Available only for HDMI[®] and AV inputs.*
- **Reset picture settings** – Returns all picture settings for the input's currently-selected **Picture mode** to their original values.

Tip: To dismiss the **Advanced picture settings** menu, just wait a few seconds without pressing any buttons. Or press ***** again to dismiss the menu immediately.

Changing privacy settings

By default, when connected to the Internet and activated with your Roku account, the TV uses an advertising identifier to track your usage behavior. You can change the privacy settings on your TV in two ways: resetting the advertising identifier and limiting ad tracking.

Note: *Privacy settings are not present on TVs operating in non-connected mode. Non-connected TVs do not display advertisements.*

Resetting the advertising identifier

Resetting the advertising identifier has the effect of clearing your prior usage history and starting over. From that point forward, your new usage patterns affect the advertisements you see on your TV.

To reset the advertising identifier:

1. From the **Home** screen menu, navigate to **Settings > System > Privacy**.
2. Highlight **Reset advertising identifier**. Press ***** to view more information about this option. When you finishing reading the information, press **OK** to close the More Information window.
3. Press **OK** to reset the advertising identifier, and then press **OK** again to dismiss the verification message.

Limiting ad tracking

You can limit Roku's tracking of your usage behavior by limiting ad tracking. When you do, your TV will display ads that are not personalized based on your TV's advertising identifier.

To limit ad tracking:

1. From the **Home** screen menu, navigate to **Settings > System > Privacy**.
2. Highlight **Limit ad tracking**. Press ***** to view more information about this option. When you finish reading the information, press **OK** to close the More Information window.
3. Press **OK** to select the **Limit ad tracking** option.

Note: If you perform a factory reset and then reconnect your TV, ad tracking is restored until you repeat these steps.

My Feed

Use My Feed to find out when you can watch movies that are “coming soon,” and to get updates on movies, TV shows, and actors that you are following.

Movies Coming Soon

My Feed gives you updates on your list of movies that are coming soon to theaters. With My Feed, you'll know when your favorite movie is ready to stream, the channels it is on, and how much it will cost.

Select the movies you want to follow by going to **My Feed > Movies Coming Soon**. You'll then see a list of newly released movies that are not yet available for streaming. Select a movie, and then select **Follow this movie on Roku**. When you return to the main **My Feed** screen, you'll see banners for each of your newly-followed movies along with banners for movies and TV shows you're already following.

Movies, TV shows, and people

In addition to following movies coming soon, you can follow any movie, TV show, or actor. To do this, use the Search feature to find the movie, TV show, or name that you want to follow, and then select **Follow this movie/TV show/person on Roku**. For more information, see “[Searching for something to watch](#)” on page 46.

Note: The TV takes a bit of time to update your newly-followed shows. Until it finds at least one channel offering the movie, the content banner in My Feed shows **Check back later for updates**.

My Feed alerts you any time a movie or TV show you are following becomes available on another channel and whenever its price changes. A number in parentheses next to **My Feed** in the **Home** menu means that My Feed has updated information that you haven't viewed yet. For example, you if three of your followed shows have updates, you'll see **My Feed (3)**.

Note: *When a movie or TV show you are following becomes available, the streaming channel offering the movie might require that you subscribe or pay a fee to view it.*

Tip: *My Feed is available only if your TV is connected to the Internet.*

Searching for something to watch

Searching for movies and shows across multiple streaming channels is one of the unique features of your TCL• Roku TV. Within a single search operation, you can search by:

- Movie name
- TV show name
- Actor or director name
- Streaming channel name
- Game name

Tip: *Roku Search is available only if your TV is connected to the Internet.*

Note: *Roku Search doesn't search across all streaming channels, but searches across lots of popular streaming channels. The actual channels it searches vary by locale, but include popular providers such as Netflix and several others, with more being added all the time.*

You can check which streaming channels are included in Roku Search by going to the **Search** screen, clearing all previous searches to reveal the search instructions, and then watching the channel tiles cycle at the bottom of the screen.

To search, select **Search** on the **Home** screen menu. The **Search** screen has a keyboard grid and initially displays instructions—a set of icons representing search categories and a list of participating provider tiles.

Tip: *If you don't see the instructions, navigate to the end of the list of recent searches and select **Clear recent search selections**.*

How do I search?

To search, use the arrow buttons to navigate the on-screen keyboard, entering a few characters of the search term. With each additional character you enter, you narrow down the search and the search results become more relevant.

Press  to start Voice Search, and then say the name of a movie, TV show, actor, or director. The TV shows you the result of your search and lists the streaming channels that offer the requested content.

Tip: Use the free Roku mobile app on your compatible smartphone or tablet to make searching even faster. Not only can you use your device's keypad to type, you can search simply by touching the voice search icon and saying the name of the movie, TV show, actor or director, channel, or game.

An icon next to each search result shows the category of the result (movie, TV show, actor).

- Press the **RIGHT** arrow to move the highlight into the list of search results.
- Press the **UP** and **DOWN** arrows to scroll through the list of search results to highlight the item you want to view.

I found a show, now what?

Now that you've highlighted the show, movie, actor, game, or streaming channel you were looking for, press the **RIGHT** arrow.

If your search result was an actor, director, or other item that does not represent a single item of content, you'll see another list to narrow down your search. Continue highlighting results and pressing the **RIGHT** arrow until you find a single, viewable content item.

- An **HD** logo means that the content is available in high-definition.
- The checked circle adjacent to the title means you have already added the streaming channel.

If your search result was a game or a streaming channel, you'll see detailed information, images, and available actions, such as a list of streaming channels and the cost of getting the item or channel.

Note: Some channels may require a subscription.

Following on Roku

Rather than watch the show you found in Search, you can add it to My Feed and wait until it's available on a particular streaming channel or available at a better price. From the search results screen, select **Follow on Roku**. Then go to **My Feed** periodically to check for updates to each of your followed movies, TV shows, or people. For more information, see "[My Feed](#)" on page [45](#).

Recent Searches

The next time you use Roku Search, the **Search** screen displays a list of recent search selections in place of the search instructions.

Using the recent search selections list makes it easy to quickly get to a previously found item, for example, to find another movie with the same actor, or another TV show in the same series.

Using the Roku Channel Store

The **Streaming Channels** menu option takes you to the Roku Channel store, where you can add new streaming channels to your TV.

Tips:

- The **Streaming Channels** menu option is available only if your TV is connected to the Internet.
- You also can search for streaming channels by using the **Search** option, as explained in [“Searching for”](#) on page 46.

To make it easier to find what you want, the streaming channels in the Roku Channel Store are categorized by topic. Press the **UP** and **DOWN** arrows to highlight the category you want, and then press the **RIGHT** arrow to move the highlight into the grid of streaming channel tiles.

When you find a streaming channel you want to add or learn more about, highlight it and press **OK** to display more details.

- If the streaming channel you are adding is free, you can select **Go to channel** to start watching it immediately.
- If there is a one-time or recurring fee associated with using the streaming channel, you must agree to the terms and conditions, accept the fee, and—if you created one when you activated your Roku TV, enter your Roku PIN code to authorize the charges.
- If you already have a subscription to the streaming channel—for example, you already subscribe to Netflix or you receive HBO through your cable TV provider—you must complete a different, simple authorization step to add the streaming channel.

You only have to complete the authorization or activation step one time, when you initially add the streaming channel. After that, you simply select the streaming channel tile from your **Home** screen to start watching. (Channel and content availability is subject to change. Charges may apply to your selection.)

Tip: *New streaming channels are added continuously, so be sure to check back every now and then.*

Note: *If you don't remember your PIN, or if you want to change whether you need to use a PIN to make purchases on your Roku account, see ["Changing your Roku Channel Store PIN preference"](#) on page [72](#).*

Customizing your TV

There are several things you can do to personalize your TV.

Rearrange tiles

Whenever you add a TV input tile, it's added at the top of your **Home** screen. Whenever you add a new streaming channel from the Roku Channel Store, it's added at the bottom of your **Home** screen.

You can easily rearrange the order of the tiles on the **Home** screen to suit your viewing preferences. For example, you might want **Antenna TV** to be the first tile in your **Home** screen. But if you mostly watch one streaming channel, you might want its tile to be the first one on your **Home** screen.

Rearranging tiles is easy:

1. From the **Home** screen, highlight one of the tiles you want to move.
2. Press ***** to display a list of options for the type of tile you selected.
3. Select **Move input** or **Move channel**. The list of options disappears and the highlighted tile shows arrows indicating how it can be moved

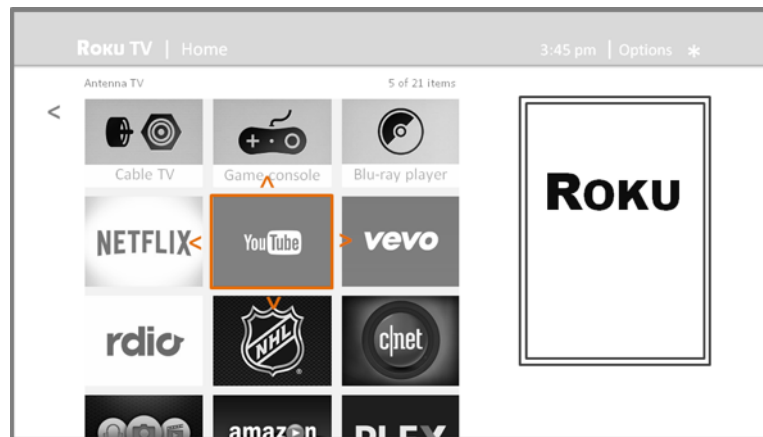

4. Use the arrow buttons to move the highlighted tile to its new position. As you move the tile, it pushes other tiles out of its way.
5. Press **OK** to lock the tile into its new position.
6. Repeat these steps to move other tiles until you have arranged your **Home** screen to your liking.

Edit broadcast TV channel lineup

When you set up the TV tuner as described in “[Setting up Antenna TV](#)” on page 28, the TV adds all the channels with good signals that it could detect in your area. It’s likely that you now have more channels than you want in your channel list.

To edit the channel lineup, from the **Home** screen, navigate to **Settings > TV inputs > Antenna TV > Edit channel lineup**. You’ll see a screen listing all of your channels. Adjacent to the list of channels is a miniature TV screen playing the highlighted channel’s picture and sound.

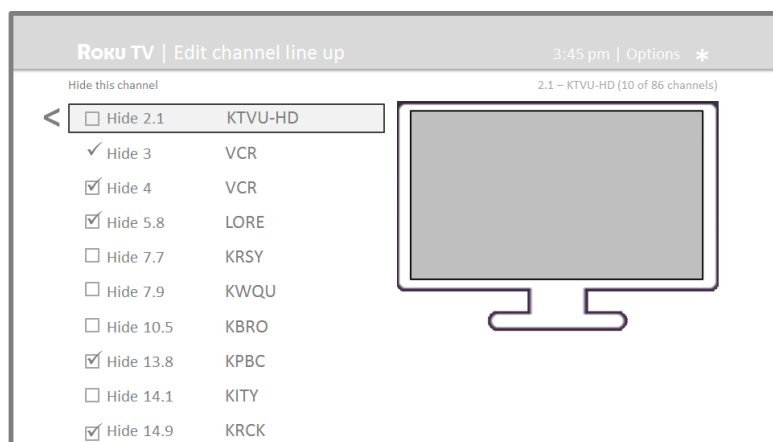

Highlight each channel you want to hide, and then press **OK** to hide the channel.

Tip: *If you need to see or hear the highlighted channel, wait a couple of seconds for the TV to start playing the channel’s picture and sound. Also note that if you’ve enabled parental controls and the program on the current channel is blocked, you won’t see a picture or hear sound while editing the channel lineup.*

Rename inputs

Rather than trying to remember that your Blu-ray player is connected to HDMI 1 and your game console is connected to HDMI 3, you can rename the TV inputs to match the connected component.

Note: *Renaming an input also changes the icon associated with it.*

To rename an input, you can either:

- Highlight the input tile in the **Home** screen, and then press ***** to display a list of options. From the list of options, select **Rename input**. Then select a new name and icon.

or

- From the **Home** screen, navigate to **Settings > TV inputs**. On the **TV inputs** screen, select the input you want to rename, select **Rename**, and then choose a new name and icon from the provided list.

Press  to return to the **Home** screen. The new name and icon are now in effect.

Remove unwanted tiles

It's easy to remove unused TV inputs and unwanted channel or app tiles. For example, if you never use the HDMI 3 input, or if you don't like the weather app you added from the Roku Channel Store, you can remove them from your **Home** screen.

Note: *You also can remove the **Antenna TV** tile if you never use the TV tuner. But be aware that removing the Antenna TV tile also deletes the broadcast TV channel list. You'll have to set up the TV tuner again next time you want to view broadcast TV. Instructions for setting up the TV tuner can be found in "[Setting up Antenna TV](#)" on page [28](#).*

- To remove any tile, highlight the input tile in the **Home** screen, and then press ***** to display a list of options. From the list of options, select **Remove input**. In the screen that follows, confirm you want to remove the input.
- Alternatively, to remove a TV input tile from the **Home** screen, navigate to **Settings > TV inputs**. On the **TV inputs** screen, select the input you want to remove, and then select **Remove > Confirm**. Then press  to return to the **Home** screen.

Change themes

Another way to customize your TV is to change its theme. The theme establishes the look and feel of the TV through colors, designs, and fonts.

Tip: *Themes are available only when your TV is connected to the Internet. Some themes require payment.*

To change the theme, in the **Home** screen menu navigate to **Settings > Themes**. In the **Themes** screen, choose from the following options:

- **My themes** – Highlight a theme, and then press **OK** to switch to that theme.
- **Custom settings** – Turn **Featured themes** on or off. When **Featured themes** is on, the TV automatically switches to featured themes—like certain holiday-inspired themes—for a limited time whenever Roku makes them available, and then switches back to your selected theme when the featured theme expires. When off, the TV always uses your selected theme.

Change sound effects volume

Sound effects are the noises the TV makes to let you know it received your command. You can change the volume of sound effects or turn them off.

To adjust the sound effects volume, in the **Home** screen menu, navigate to **Settings > Audio > Menu volume**. Navigate to the right and then change the setting to **High, Medium, Low, or Off**.

Configure power settings

Power settings let you set up your TV so that it turns on to the location you choose. Power settings also help your TV save energy by automatically turning it off under certain conditions.

Power on settings

Power on settings tell the TV what to do when you turn on the power. To configure the power on settings, from the Home screen menu, navigate to **Settings > System > Power > Power on**. Highlight the power on location from the list, and then press **OK** to select it.

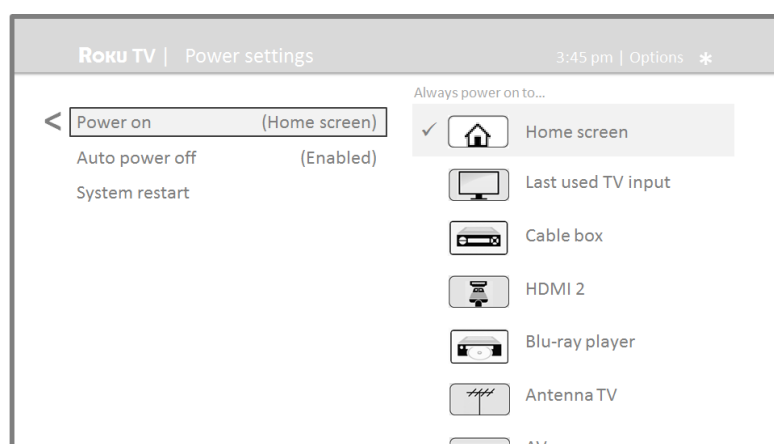

Auto power off settings

To help you save energy, your TV can automatically turn itself off after a period of inactivity or a period during which no signal has been detected. It is factory-configured to do both of these things, but you can change these settings if needed.

To configure automatic power off, from the **Home** screen menu navigate to **Settings > System > Power > Auto power savings**. In the **Power settings** screen, highlight the following options and press **OK** to turn them on or off:

- **Reduce power after 15 minutes** – If no video or audio activity and no user interaction occur for 15 minutes, the TV automatically turns off the screen and sound.
- **Turn off after 4 hours** – If no video or audio activity and no user interaction occur for 4 hours, the TV goes into standby mode.

Configure parental controls

Parental controls enable you to control whether the members of your household can view certain kinds of broadcast TV programs. When a program or feature is blocked, you can unblock it by entering a parental control PIN that only you know.

Note: *The parental control feature can be used to hide the **Movie Store**, **TV Store**, and **News** options that are available on the **Home** screen menu of TVs manufactured for the United States. However, the parental controls feature does not block other streaming content nor content from inputs other than the TV tuner.*

Creating a parental control PIN

The first time you access the **Parental controls** screen, you must create a new parental control PIN. Thereafter, whenever you want to change parental control settings, unblock programming that has been blocked, change the PIN, or disable parental controls, you must enter your parental control PIN.

Tip: *Your parental control PIN has nothing to do with your Roku PIN. You can make them the same if you want—this is entirely your choice.*

To create a new parental control PIN, from the **Home** screen menu navigate to **Settings > Parental controls**. The screen displays a numeric keypad. Use the arrow buttons and the **OK** button to enter a four digit code. Then repeat the process to enter the same PIN again, just to make sure you correctly entered the PIN you want to use.

Important: *If you forget your parental control PIN, the only way to recover is to perform a factory reset operation, as explained in “[Factory reset everything](#)” on page 71. Be sure to write it down in a safe place just in case.*

Blocking Movie Store, TV Store, and News (US TV models only)

One of the parental control options is to completely hide the entertainment options that are available directly on the **Home** screen menu of TVs manufactured for sale in the United States. (The Movie Store, TV Store, and News options are not available on TVs manufactured for sale in Canada).

To hide **Home** screen entertainment options:

1. From the **Home** screen menu, navigate to **Settings > Parental controls**, and then enter your parental control PIN.
2. In the **Parental controls** screen, highlight **Home screen** and then select or clear either of these options:
 - **Hide “Movie Store and TV Store”** – Removes the **Movie Store** and **TV Store** options from the **Home** screen menu.
 - **Hide “News”** – Removes the **News** option from the **Home** screen menu.

Tip: *To use either of these options after you’ve hidden them, you must return to this screen and remove the check mark from the corresponding **Hide** command.*

Blocking Broadcast TV shows

For broadcast TV, parental controls use information embedded in the broadcast signal to determine whether to allow a program to be displayed. Parents can configure parental controls to block broadcast TV programs that meet or exceed a specific rating, so they cannot be viewed or heard unless the correct parental control PIN is entered.

Note: *Rating standards differ by country.*

Enabling parental control of TV shows

The first step in blocking TV shows is to enable parental control of TV shows.

This setting is provided separately to make it easier for you to turn parental control of TV shows on and off without disturbing their settings. For example, your kids are going to summer camp for two weeks, and while they are gone, you don’t want to have to deal with unblocking shows that you want to watch by entering your parental control PIN. All you need to do is clear **Enable parental controls**, and all TV shows are unblocked. When the kids return, select **Enable parental controls** again, and all of your parental control settings are restored in a single operation.

To enable parental control of TV shows:

1. In the **Home** screen menu, navigate to **Settings > Parental controls**, and then enter your parental control PIN.
2. In the **Parental controls** screen, navigate to **TV tuner > Parental control of TV shows**.
3. Make sure the check box next to **Enable parental controls** is checked. If not, highlight it and press **OK**.

Blocking based on US TV ratings

Most broadcast US TV shows—other than movies—contain rating data that enables parental controls to block shows that parents don't want others to view. The ratings are divided into two groups that function independently:

- **Youth group** – TV-Y, TV-Y7
- **Main group** – TV-G, TV-PG, TV-14, TV-MA

Within each of these groups, the ratings interact such that if you block a particular level of content, the TV also blocks all content with a higher rating. Conversely, if you unblock a particular level of content, the TV also unblocks all content with a lower rating. For example, if you block TV-PG programs, the TV also blocks TV-14 and TV-MA programs. If you subsequently unblock TV-14 programs, TV-PG programs are also unblocked, but TV-MA programs remain blocked.

Similarly, within the main group, content types can be individually blocked. For example, you can block just coarse language in shows with a TV-PG rating. If you do, then the TV also blocks shows with coarse language in the higher ratings (TV-14 and TV-MA). Subsequently unblocking coarse language in TV-14 ratings does not unblock coarse language in TV-MA programs, but it does unblock coarse language in TV-PG programs.

To block TV shows based on US television ratings:

1. From the **Home** screen menu, navigate to **Settings > Parental controls**, and then enter your parental control PIN.
2. In the **Parental controls** screen, navigate to **TV tuner > TV ratings**. Choose among the following settings:
 - **Entire ratings** – Highlight the rating you want to block, and then navigate to the right and select the first option that blocks the entire rating level (and all higher rating levels).
 - **Individual content types** – Highlight the rating that contains the content type you want to block, and then select the content types you want to block from among those listed. Remember that blocking a content type in one rating blocks the equivalent content type in all higher rating levels.

Blocking based on US movie ratings

Most movies in the US are rated by the Motion Picture Association of America, or MPAA, so the ratings are known as MPAA ratings. TV broadcast signals carry movie rating data that enables parental controls to block shows that parents don't want others to see. The ratings are:

- G – General audiences
- PG – Parental guidance suggested
- PG-13 – Parents strongly cautioned for children age 13 or younger
- R – Restricted
- NC-17 – Not for age 17 or younger

Unlike US TV ratings, there are no individual content types within the ratings. But like TV ratings, blocking movies with a particular rating also blocks movies with a higher rating, and unblocking movies with a particular rating also unblocks movies with a lower rating.

Tip: *Blocking movies with an NC-17 rating also blocks programs with the now-obsolete X rating, which can still occur in the program data of older movies.*

To block movies based on MPAA ratings:

1. From the **Home** screen menu, navigate to **Settings > Parental controls**, and then enter your parental control PIN.
2. In the **Parental controls** screen, navigate to **TV Tuner > Movie ratings**.
3. Select the rating level you want to block. You need only select one rating level, and all higher levels are automatically blocked.

Blocking based on Other ratings

Your TV can block programs having ratings that had not been defined when the TV was manufactured. It does this by detecting a new Rating Region Table in a program and then downloading the new table and displaying its rating in the Parental controls.

When the TV downloads a new Rating Region Table, it adds a new option to the list of rating types: **Other ratings**. If you see this option in the **Parental controls** screen, you have tuned to a station that has implemented a new rating table. Once the new rating table has been downloaded to the TV, it remains in the TV until it is factory reset, and you can configure blocking based on the new ratings.

New Region Rating Tables can have independent rating levels, or rating levels that interact in the same ways as the built-in US TV and MPAA Movie ratings.

Tip: *If your TV downloads a new Region Rating Table, you'll have to experiment with its settings to understand how to use it.*

Blocking based on Canadian English ratings

Canadian-English language and third-language programs that are broadcast in Canada are rated by the Action Group on Violence on Television, or AGVOT. TV broadcast signals carry rating data that enables parental controls to block shows that parents don't want others to view based on content containing violence, language, sex, or nudity. The ratings are:

- C – Children under 8 years

- C8 – Children 8 years and older
- G – Generally suitable for all age groups
- PG – Parental guidance suggested for viewers under 14 years
- 14+ – Generally not suitable for viewers under 14 years
- 18+ – Generally not suitable for viewers under 18 years

Blocking content with a particular rating also blocks content with a higher rating, and unblocking content with a particular rating also unblocks movies with a lower rating.

To block programs based on AGVOT ratings:

1. From the **Home** screen menu, navigate to **Settings > Parental controls**, and then enter your parental control PIN.
2. In the **Parental controls** screen, navigate to **TV tuner > Canadian English ratings**.
3. Select the rating level you want to block. You need only select one rating level, and all higher levels are automatically blocked.

Blocking based on Canadian French ratings

Canadian-French language programs that are broadcast in Canada are rated by the Régie du cinéma du Québec. TV broadcast signals carry rating data that enables parental controls to block shows that parents don't want others to view based on content containing violence, language, sex, or nudity. The ratings are:

- G – Generally suitable for all age groups
- 8+ – Viewers 8 years and older
- 13+ – Viewers 13 years and older
- 16+ – Viewers 16 years and older
- 18+ – Adults only

Blocking content with a particular rating also blocks content with a higher rating, and unblocking content with a particular rating also unblocks movies with a lower rating.

To block programs based on Canadian-French ratings:

1. From the **Home** screen menu, navigate to **Settings > Parental controls**, and then enter your parental control PIN.
2. In the **Parental controls** screen, navigate to **TV tuner > Canadian French ratings**.
3. Select the rating level you want to block. You need only select one rating level, and all higher levels are automatically blocked.

Blocking unrated programs

Some broadcast TV shows and movies are assigned a rating of “Unrated”. Whether or not such programs contain content that is objectionable to you cannot be determined. However, you can choose to block such programs.

To block all unrated broadcasts:

1. From the **Home** screen menu, navigate to **Settings > Parental controls**, and then enter your parental control PIN.
2. In the **Parental controls** screen, navigate to **TV tuner > Block all unrated programs**.
3. Highlight **Unrated programs** and press **OK**. When blocking is enabled, the adjacent padlock icon changes from unlocked to locked.

Tip: Blocking programs that have been assigned a rating of “Unrated” does not block programs that have no rating assigned to them (for example a broadcast of a local town council meeting). Programs that do not have an assigned rating display **Rating NA** (for “not applicable, meaning a rating is not needed”). Programs that have no assigned rating are considered “safe”; therefore, there is no need to block them.

What happens when a TV show is blocked?

After you’ve set up parental controls, TV shows and movies can be blocked:

- When you change channels and the new channel is playing a program whose rating exceeds your settings.
- When a new show comes on the channel you are watching and its rating exceeds your settings.

When a program is blocked by parental control settings, the TV displays a blocked message:

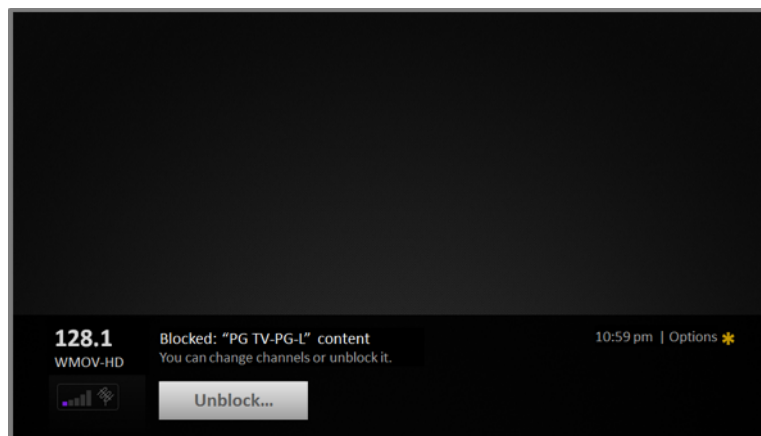

Whenever this blocked message appears, both the video and audio of the show are blocked, as well as program data that would normally appear in the area at the bottom of the screen.

To watch the blocked program, you need to know the PIN code defined when you enabled parental controls, as explained in [“Creating a parental control PIN”](#) on page 55.

1. Press **OK** to select **Unblock** and display a PIN pad.

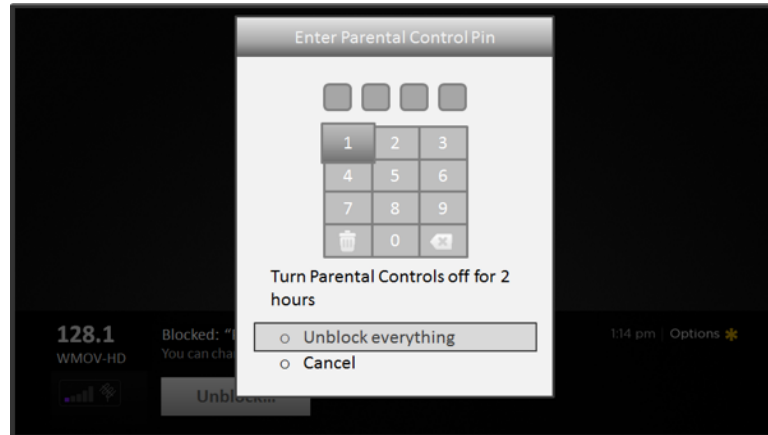

2. Use the arrow buttons to enter your parental control PIN code, and then press **OK** to select **Unblock everything**.

After unblocking shows that have been blocked, all blocking is disabled for two hours or until you turn off the TV.

Changing the parental control PIN

To change your parental control PIN:

1. From the **Home** screen menu, navigate to **Settings > Parental controls**, and then enter your parental control PIN.
2. In the **Parental controls** screen, highlight **Change PIN**.
3. Move the highlight into the adjacent keypad, and then use the arrow buttons and the **OK** button to enter a four digit code. Then repeat the process to enter the same PIN again, just to make sure you correctly entered the PIN you want to use.

Resetting parental controls

So now your kids have grown up and gone away to college, and you no longer want to deal with blocked programs.

To erase all parental control settings:

1. From the **Home** screen menu, navigate to **Settings > Parental controls**, and then enter your parental control PIN.
2. In the **Parental controls** screen, highlight **Reset parental controls**.

3. Follow the instructions on the screen to confirm that you want to erase all parental control settings.

Tip: *Resetting parental controls also erases your parental control PIN.*

More settings

This section describes the features and settings of the TV that were not covered in the other parts of this guide.

Changing network settings

If needed, you can change your network settings at any time. For example, if you change the name of your wireless network (its SSID) or its password, you will need to change your TV's settings so that it can continue to connect. Also, if you decided not to connect to the Internet in "[Guided Setup](#)" on page [15](#), you can use Network settings to connect at a later time.

To change network settings, from the **Home** screen menu, navigate to **Settings > Network**, and then press the **RIGHT** arrow. At this point, you can choose the following options:

- **Update connection** – Select your existing network connection type (**Wireless** or **Wired**), and then press **OK** to start the update process. The TV uses your current network information to reconfirm the wireless or wired network connection, the local network connection, and the Internet connection.
- **Set up new connection** – Select a different network connection types (**Wireless** or **Wired**), and then select the option to set up a new connection. Follow the on-screen instructions to complete the network connection. For help with setting up a new connection, see "[Setting up your TV](#)" on page [16](#).

***Note:** Some networks, such as those found in dorm rooms, hotels, and other public places, may require you to read and agree to terms, enter a code, or provide identifying information before letting you connect to the Internet. If the TV detects that you are connecting to such a network, it prompts you through the connection process using your smartphone or tablet to provide the needed information. For more information, see "[Using your TV in a hotel or dorm room](#)" on page [36](#).*

Changing caption settings

You can change many different settings that affect the appearance of captions.

To change caption settings, from the **Home** screen menu, navigate to **Settings > Captions**, and then press the **RIGHT** arrow. At this point, you can choose the following options:

- **Captions mode** – Choose **Off, On, Instant replay, or When mute**.
 - If you choose **On**, the TV displays captions whenever they are available in the program information. *This setting applies to Antenna TV, the AV input, and streaming channels.*
 - If you choose **Instant Replay**, the TV displays captions only during a replay operation; that is, after pressing ↶ to jump back a few seconds in streaming video. *This setting applies only to streaming channels when the program being streamed supports instant replay.*
 - If you choose **When mute**, the TV displays captions only when the sound is muted. *This setting applies to Antenna TV, the AV input, and streaming channels.*

Note: If ↶ is not available on your remote control, you can use ↶ on the Roku App or the **Jump Back** button on a universal remote. For more information, see [“Other devices”](#) on page [75](#).

This setting reflects the **Closed captioning** settings in the **Options** menu for certain TV inputs, as explained in [“Options menu settings”](#) on page [40](#). *Note that, once enabled, the captions mode remains set for all applicable inputs until you turn it off.*

Tip: *Some streaming channels require you to enable captions through a setting within their channel even though you have turned on captions everywhere else.*

- **Text style** – Choose from a list of fonts. As you move the highlight to each font, you can see a sample of the result in an adjacent panel.
- **Text edge effect** – Choose from a list of edge effect styles, such as raised, depressed, and various shadows. As you move the highlight to each effect, you can see a sample of the result in an adjacent panel.
- **Text size** – Choose from a list of sizes. As you move the highlight to each size, you can see a sample of the result in an adjacent panel.
- **Text color** - Choose from a list of colors for the text. As you move the highlight to each color, you can see a sample of the result in an adjacent panel.
- **Text opacity** - Choose from a list of opacity settings for the text. This setting determines how much the area behind the text shows through the text. A value of 100% blocks all of the content behind the text. As you move the highlight to each setting, you can see a sample of the result in an adjacent panel.

- **Background color** - Choose from a list of colors for the background area behind the text. As you move the highlight to each color, you can see a sample of the result in an adjacent panel. Note that you won't see any change unless you set the **Background opacity** to a value other than **Off**.
- **Background opacity** - Choose from a list of opacity settings for the background of the caption. This setting determines how much the area behind the caption background shows through the background. A value of 100% blocks all of the content behind the background. As you move the highlight to each setting, you can see a sample of the result in an adjacent panel.
- **Window color** - Choose from a list of colors for the window rectangle surrounding the entire caption. As you move the highlight to each color, you can see a sample of the result in an adjacent panel. Note that you won't see any change unless you set the **Window opacity** to a value other than **Default** or **Off**.
- **Window opacity** - Choose from a list of opacity settings for the window rectangle surrounding the entire caption. This setting determines how much the area behind the caption window shows through the window. A value of 100% blocks all of the content behind the window. As you move the highlight to each setting, you can see a sample of the result in an adjacent panel.

Changing time settings

You can change time settings to suit your preferences. You can find the following settings by navigating from the **Home** screen menu to **Settings > System > Time**:

- **Sleep timer** – Set a time delay after which the TV will automatically shut off. This setting reflects the setting you can make in the **Options** menu from any TV input, as explained in “[Options menu settings](#)” on page [40](#). *Note that the sleep timer setting is not input specific.*
- **Time zone** – Select whether to set the time zone automatically or manually, and if set manually, select your current time zone. Typically, a TV connected to the Internet can discover its own time zone automatically, and a TV that is not connected to the Internet must be set manually. Initially, this setting is made when you set up the TV tuner, as explained in “[Setting up Antenna TV](#)” on page [28](#). Correct time zone information is needed to correctly display program data.
- **Clock format** – Select whether to display time in a 12-hour or 24-hour format, or to turn off time display. *This setting is available only on TVs that are connected to the Internet. Non-connected TVs do not display the time.*

Scanning for broadcast TV channels again

There will be times when you need to create a new channel list. For example, you:

- Change cable providers
- Reorient your TV antenna
- Move to a different city with different channels

Whenever you need to update your TV channel list, you can repeat the channel scan.

Tip: Repeat the channel scan from time to time to make sure you are receiving all of the latest channels. Broadcasters add and remove channels, move channels to different parts of the spectrum, and change the power levels of their channels periodically.

To repeat the channel scan, from the **Home** screen menu, navigate to **Settings > TV inputs > Antenna TV > Scan again for channels**. Then select **Start finding channels** to begin the channel scan process. The screens and options that appear during this process are identical to those described in [“How do I set up the TV tuner?”](#) on page 28.

Setting the HDMI mode

You can independently configure each HDMI input to match the capabilities of the connected device. From the **Home** screen menu, navigate to **Settings > TV inputs**, and then select an enabled HDMI input. Next, select **HDMI mode** and then select one of the following settings:

- **Auto** – Let the TV determine the best setting. Use this option unless your HDMI device does not correctly communicate its HDMI version compatibility.
- **HDMI 1.4** – Configure the input for compatibility with HDMI version 1.4, which supports a maximum refresh rate of 30 Hz at full UHD resolution. Most HDMI devices will work correctly with the TV in this mode.
- **HDMI 2.0** – Configure the input for compatibility with HDMI version 2.0, which supports a maximum refresh rate of 60 Hz at full UHD resolution. Many older HDMI devices will not work correctly if the TV’s HDMI input is configured for this mode.

Using the TV in a home theater

Your TV has several features that make it an ideal TV for a home theater. But you might not notice them because they remain in the background until you decide to use them.

Turning off the speakers

When you use your TV with a sound bar or an external amplifier and speakers, you'll probably want to turn off the internal TV speakers.

To turn off the TV's built-in speakers, in the **Home** screen menu, navigate to **Settings > Audio > TV speakers** and change the setting.

***Tip:** The TV's internal speakers can be enabled and disabled automatically as needed by system audio control, as described in ["Enabling system audio control"](#) on page 69. The internal speakers are also turned off when you use the headphone jack.*

Changing the audio mode

The TV has two audio modes, accessed by navigating in the **Home** screen menu to **Settings > Audio > Audio mode**:

- **Stereo** – Use this setting for internal speakers, headphones, and external stereo amplifiers connected through HDMI[®] ARC, SPDIF optical, or headphone jack.
- **Auto** – Use this setting to automatically detect the best audio setting based on the audio stream in the content you are watching. If you have connected the TV to an external Dolby Digital or Dolby Digital Plus compatible amplifier, receiver, or sound bar through HDMI[®] ARC or SPDIF optical, the TV automatically selects the appropriate surround sound capabilities of the device based on the characteristics of the current program.

Setting up a digital audio connection

You can connect the TV to an external amplifier, receiver, or sound bar by using either of these two connections:

- **HDMI ARC** – The HDMI® Audio Return Channel enables the TV to output digital audio on one of its HDMI® connectors. The connected amplifier can also function simultaneously as an input source to the TV, if needed. To use the ARC capability, you must connect an HDMI® cable from your amplifier’s HDMI® ARC connector to the HDMI ARC connector on the TV. You also must:
 - Be sure your HDMI® cable is certified by HDMI®.
 - Enable **HDMI ARC** under **Settings > System > Control other devices (CEC)**, as explained in “[Enabling HDMI® ARC](#)” on page [69](#).
- **SPDIF optical** – The TV has an SPDIF optical connector that outputs a digital audio signal. To use the optical output, connect a TOSLINK optical cable from the amplifier to the Optical or SPDIF connector on the TV.
- **Note:** *Dolby Digital Plus format is not available through the SPDIF optical output. This format is only available through the HDMI® ARC connection.*



After making the required HDMI® ARC or SPDIF optical connection, go to **Settings > Audio > S/PDIF and ARC** option and select the audio format to use.

Note: In most cases, **Auto detect** is the best option. Other settings can result in no sound when the content you are viewing does not contain the audio stream type you selected.

Controlling other devices through CEC

Consumer Electronics Control (CEC) enables your TV and other CEC-compatible home entertainment components to control one another in various ways. First, the CEC-compatible devices must “discover” one another and report their capabilities. After this, one device can control another according to the features you enable. For example, playing a disc on a Blu-ray player could switch the TV to the Blu-ray player’s input. Or, powering off the TV could also power off the Blu-ray player and the home theater receiver.

Discovering connected CEC devices

To discover CEC devices:

1. Make sure that your CEC-compatible components are connected to the TV with a suitable high-speed HDMI® cable that supports HDMI® ARC and CEC control.
2. Turn on each component and make sure all components are CEC enabled.

Tip: *Some manufacturers have their own branded names for CEC functionality, so you might need to read the product documentation to correctly identify the CEC features of the device.*

3. On the TV’s **Home** screen menu, navigate to **Settings > System > Control other devices (CEC)** and then select **Search for CEC devices**. Press **OK** to repeat the discovery process, if necessary.

When finished, the TV displays a list of CEC devices that are connected to each HDMI® input, as well as any devices that had previously been connected. The TV remembers the names of multiple CEC devices even when they are no longer connected. If the list is longer than the allowed space, press ***** to see a complete list in a scrollable window.

Enabling HDMI® ARC

HDMI® ARC is the audio return channel that is available on one of the TV's HDMI® ports. The audio return channel enables you to send a Dolby Digital audio signal back to a home theater receiver that is also sending an audio and video signal into the TV. Using HDMI® ARC reduces the number of cables needed and optionally lets you control the volume and mute state of the receiver by enabling system audio control.

HDMI® ARC is disabled by default. To enable HDMI® ARC, in the **Home** screen menu, navigate to **Settings > System > Control other devices (CEC)**, and then highlight **HDMI ARC**. Press **OK** to enable or disable the feature.

Note: Enabling **HDMI ARC** also enables **System audio control**. After enabling **HDMI ARC**, you can disable **System audio control** if you prefer.

Enabling system audio control

System audio control enables the TV remote control to change the volume and mute state of an amplifier or sound bar connected through HDMI®, and to display the external device's volume and mute status in the TV's on-screen display.

The TV automatically turns off its internal speakers and sends volume and mute control signals to an external amplifier when all of the following are true:

- **System audio control** is enabled on the TV.
- The TV is connected to a CEC-compatible amplifier, it is powered on, and CEC discoverability is enabled.
- The CEC-compatible amplifier's HDMI® ARC connector is connected to the TV's HDMI ARC connector with a suitable HDMI® cable.

When the CEC-compatible amplifier is off, the TV automatically turns on its speakers (unless you have turned them off as described in "[Turning off the speakers](#)" on page [67](#)) and resumes local control of volume and mute state.

To enable or disable system audio control, in the **Home** screen menu, navigate to **Settings > System > Control other devices (CEC)** and highlight **System audio control**. Press **OK** to enable or disable the feature.

Enabling 1-touch play

1-touch play enables a component to control which TV input is active. For example, pressing **Play** on your Blu-ray player switches the TV to the Blu-ray input.

1-touch play is disabled by default. To enable 1-touch play, in the **Home** screen menu, navigate to **Settings > System > Control other devices (CEC)** and highlight **1-touch play**. Press **OK** to enable or disable the feature.

Enabling system standby

The system standby feature causes other components to power off when you power off your TV. Depending on the CEC System Standby implementation, it also might enable connected components to power off your TV when you power off the component.

System standby is disabled by default. To enable system standby, in the **Home** screen menu, navigate to **Settings > System > Control other devices (CEC)** and highlight **System standby**. Press **OK** to enable or disable the feature.

Restarting the TV

You can restart the TV when necessary. Restarting has the same effect as unplugging the TV power and then plugging it in again.

To restart the TV, navigate to **Settings > System > Power**, and then select **System restart**. Highlight **Restart**, and then press **OK** to confirm restart.

While the TV restarts, the screen goes dark for a few seconds, and then displays the startup screen for a few more seconds. When the restart operation completes, the TV displays the activity you selected in [“Power on settings”](#) on page [54](#).

Resetting the TV

You can choose to reset only the TV picture and audio settings to their original values, or perform a full factory reset to return the TV to the state it was in when you first unpacked and turned it on.

Reset audio/video settings

To reset only the TV picture and audio settings to their original values, navigate to **Settings > System > Advanced system settings > Factory reset**, and then highlight **Reset TV audio/video settings**. Read the information on the screen to make sure you understand what the reset operation does.

To proceed with the reset operation, press **PLAY/PAUSE** three times in a row.

Factory reset everything

A full factory reset returns the TV to its original, out-of-the-box state. When finished, you must repeat Guided Setup, reconnecting to the Internet, re-linking your Roku account, and reloading any streaming channels. You also must repeat Antenna TV setup and input configuration.

Factory reset is the recommended choice if you want to transfer the TV to another owner, and it is the only choice if you want to switch from store mode to home mode (if you inadvertently selected store mode during Guided Setup).

To perform a factory reset, navigate to **Settings > System > Advanced system settings > Factory reset**, and then highlight **Factory reset everything**. Read the information on the screen to make sure you understand what this reset operation does.

To proceed with the full factory reset, use the on-screen number pad to enter the code displayed on the screen, and then select **OK** to proceed.

When the factory reset operation completes, the TV restarts and displays the first Guided Setup screen.

What if I can't access the Factory Reset option?

It is possible that your TV might get into a state where you cannot access the various menus, including the menu option that lets you perform a factory reset operation. If that happens, you can force the TV to reset by following these steps:

1. Using a straightened paper clip or ball-point pen, press and hold the recessed RESET button on the TV connector panel.
2. Continue to hold the RESET button for approximately 12 seconds.

During this time, the status light turns off, and then turns on bright, and then pulses. When the reset cycle completes, the light either comes on dim (if the TV power was off when you started) or the TV screen comes on and the light turns off (if the TV power was on when you started).

3. When the status light turns on steady dim or the TV screen comes on, release the RESET button.
4. Turn on the TV and proceed through Guided Setup. See "[Setting up your TV](#)" on page [16](#).

Changing your Roku Channel Store PIN preference

When you created your Roku account, you were given the opportunity to create a PIN code and to specify when it must be used. If you created a Channel Store PIN and want to change it, or you don't remember your PIN, or if you didn't create a Channel Store +PIN and want to add one, you can easily make these changes.

1. On a computer, tablet, or smartphone, use your web browser to go to <https://my.roku.com>.
2. Enter your email address and password to sign in. After signing in, the **My Account** page appears.
3. Under **PIN Preference**, click **Update** to open the **Choose Your PIN Preferences** page.
4. Skip this step if you just want to change your PIN. Otherwise, choose the option you prefer from among those listed:
 - Require a PIN to make purchases or to add any item from the Channel Store.
 - Require a PIN to make purchases.
 - Do not require a PIN to make purchases.
5. If you choose either of the first two options, enter your PIN twice in the appropriate boxes.
6. Click **Save Changes** to save your changes and return to the **My Account** page. Note that your current setting is described under **PIN Preference**.

Getting system updates

If your TV is connected to the Internet and linked with a Roku account, it will automatically get updates from time to time. You don't need to do anything. But if you are aware that an update is available and you don't want to wait until the TV updates itself, you can manually check for updates.

If your TV is not connected to the Internet, you can still get updates by using a USB flash drive.

You can download an updated User Guide that matches your Roku TV software version from the TCL web site at:

<http://www.tclusa.com/support/>

To determine your current Roku TV software version, go to **Settings > System > About**, and then press **OK** or navigate to the right.

Checking for updates on a connected TV

If you're one of those people who has to have the latest, most up-to-date features the moment they are available, you can check for updates as often as you want.

To check for updates, navigate to **Settings > System > System update**, and then select **Check now**. The TV responds either with a message saying that your TV is up to date, or with a message saying that an update is available.

Follow the instructions on the screen to install the system update.

Note: Sometimes system updates install new system software, and other times they install new features for streaming channels. Therefore, you won't always see a change in the behavior of your TV after a system update.

Getting updates on a non-connected TV

If your TV is not connected to the Internet, you can still get system updates by using a USB flash drive and a computer with an Internet connection.

To get a system update, navigate to **Settings > System > System update**:

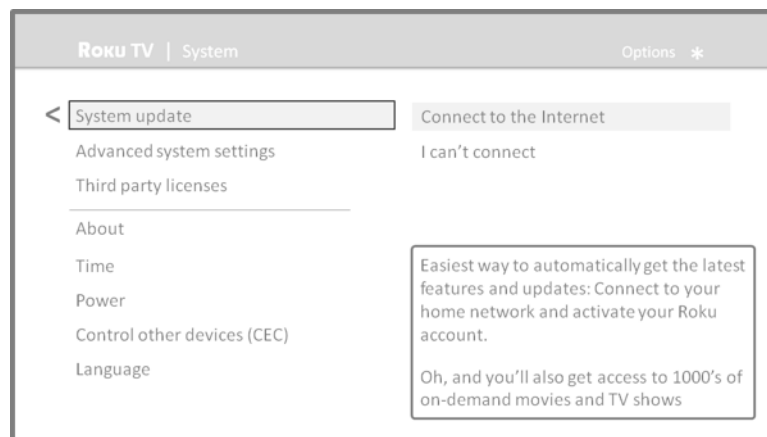

The **System update** screen on a non-connected TV gives you the opportunity to connect your TV to the Internet to automatically receive updates. We recommend this option if it is possible in your situation. To proceed, select **Connect to the Internet** and follow the instructions in "[But what if I didn't connect my TCL• Roku TV?](#)" on page [27](#).

Otherwise, if you can't connect to the Internet, select **I can't connect**, and then follow the instructions on the screen. Here's a summary:

1. On an Internet-connected computer, go to the web site displayed on the **System update** screen.

2. On the **USB Update** web page, select the correct brand and model, and then click **Next**.
3. Click **Download Software**, and then save the file to the root folder of a standard USB flash drive.
4. When the download finishes, take the USB flash drive to the TV and plug it into the USB port. When you do, the TV validates the files on the flash drive and displays a 12-digit code.
5. Write down the code and the web address, and take this information back to your Internet-connected computer.
6. On the **12-digit code** page, enter the code your TV displayed, and then click **Next**.
7. On the **6-digit code** page, write down the 6-digit code that appears, and then take it back to your TV.
8. Using the TV remote control, select **Next** to move to the next screen, and then use the on-screen keyboard to enter the 6-digit code. When finished, select **OK**. The system update begins. Do not remove the USB flash drive until the TV restarts.

USB flash drive

Any normal USB flash drive will work, provided it has a FAT-16 or FAT-32 file system format. (This is the default for most flash drives.)

The size of the download is small—usually less than 100 MB—and so will fit on any size flash drive you might have.

12- and 6-digit codes

The USB update process uses a pair of codes to validate that you are authorized to install an update, and to ensure you are not attempting to install an old, unsupported version of the system software.

When the update finishes, the TV restarts. You can check the new version number by navigating to **Settings > System > About**.

Other devices

Screen Mirroring your phone or tablet

Your TV has a feature called screen mirroring that lets you mirror your compatible smartphone or tablet on your TV. Share videos, photos, web pages, and more from compatible devices*. This screen mirroring feature is in a 'beta' period, which lets you try it out and allows Roku to learn what needs to be improved—so don't be surprised if it doesn't work perfectly.

For information on which devices may work with screen mirroring and instructions on how to use it, see <https://support.roku.com/hc/en-us/articles/208754928-Roku-screen-mirroring-overview>.

Note: *Your TV must be connected to the Internet and linked to a Roku account to use screen mirroring. The Screen Mirroring option is not available on non-connected TVs.*

Getting and using the Roku mobile app

Roku makes the Roku mobile app free for compatible iOS, Android, and Microsoft Windows 8/8.1 devices.

With the Roku mobile app, you can control your TV, find and add new Roku Channels, more easily search and find something to watch, and even use your voice to search without typing. More information can be found by going to support.roku.com/home and searching for "mobile app."

Using a universal remote

In many cases, you can program your cable or satellite universal remote control to also control your TV. You will need to have instructions for programming the remote control handy. Check with your cable or satellite provider for instructions.

For details on how to set up the TV to work with universal remote controls, visit <http://www.tclusa.com/remotecodes/>.

* Many features work with top mobile devices. Please see support.roku.com for compatibility information.

FAQ

For the latest answers to Frequently Asked Questions, visit the TCL TV support website (<http://www.tclusa.com/support/>) and the Support section of the Roku website (www.roku.com).

Other information

Battery Caution and Disposal Information

- For best results, use alkaline batteries.
- Install only new batteries of the same type in your product.
- Failure to insert batteries in the correct polarity, as indicated in the battery compartment, may shorten the life of the batteries or cause batteries to leak.
- Do not mix old and new batteries.
- Do not use Rechargeable (Nickel Cadmium) or (Nickel Metal Hydride) batteries.
- Do not mix Alkaline, Standard (Carbon-Zinc) or Rechargeable (Nickel Cadmium) or (Nickel Metal Hydride) batteries.
- Do not dispose of batteries in fire.
- Recycle or dispose of batteries as per state and local guidelines.

Electronics Recycling Information For Consumers

TCL strives to provide a high level of service to our customers and in the communities we serve, and recommends that consumers always look for a recycling or reuse alternative to throwing away televisions and other electronics. We encourage customers to recycle end-of-life electronic devices using one of the many convenient methods available today. In many states TCL has programs in place to enable consumers to drop-off and recycle televisions free of charge. For information on electronics recycling in all 50 states, including drop-off locations, please visit the “Electronics Recycling” area of the TCL USA website at www.tclusa.com.

Care and Cleaning

- **Caution:** Turn off your TV before cleaning.
- Clean the TV as needed using a soft lint-free cloth. Be sure to occasionally dust the ventilation slots in the cabinet to help assure adequate ventilation.
- **IMPORTANT:** Never use strong cleaning agents, such as ammonia-based cleaners, or abrasive powder. These types of cleaners will damage the TV. The TV’s screen may be cleaned with a soft, lint-free cloth as well. Take care not to scratch or mar the screen. If necessary, you may use a cloth dampened with warm water. While cleaning, do not spray liquid directly on the screen, or allow liquid to run down the screen and inside the TV. Also,

never place drinks or vases with water on top of the TV. This could increase the risk of fire, shock hazard or damage to the TV.

Television Specifications

- Broadcasting system US System NTSC-M, ATSC standard (8VSB), QAM
- Receiving Channels VHF2-13, UHF14-69, CATV 14-36 (A)-(W), 37-59 (AA)- (WW), 60-85 (AAA)-(ZZZ), 86-94 (86)-(94), 95-99 (A-5)-(A-1), 100-135(100)-(135), 01 (4A)
- Tuner type Frequency synthesized
- Operating Temperature 5°C to 35°C (41°F to 95°F)
- Operating Humidity 20% to 80%, non-condensing
- Storage Temperature -15°C to 45°C (5°F to 113°F)
- Storage Humidity 10% to 90%, non-condensing

Notices

TTE Technology, Inc. (“TTE”) Limited Warranty

All TCL LCD/LED Models

What your warranty covers: Defects in materials or workmanship to the **original owner** of this TCL product when purchased **as new from an Authorized Dealer** of TCL brand products in the United States and packaged with this warranty statement.

New LCD/LED Televisions (Non-Commercial Use)

For how long after your purchase:

- **One (1) year from date of purchase** for parts and labor for **non-commercial use**.

New LCD/LED Televisions (Commercial Use)

For how long after your purchase:

- **Six (6) months from date of purchase for parts and labor for commercial use.**
- Commercial use includes, but is not limited to, the use of this product in a commercial or business environment, the use of this product in an institution or for institutional purposes, or other commercial purposes including rental purposes.

What we will do

- At TTE’s discretion, (1) pay an Authorized TCL Service Center for both labor charges and parts to repair your television, or (2) replace your television with a new or refurbished/remanufactured equivalent value product. The decision to repair or replace will be made solely by TTE. See “How to get service”.

How to get service

- Please have your original purchase receipt or proof of purchase (bill of sale or receipted invoice) which states that condition of the unit (New, Used, etc.), the unit's date of purchase, place of purchase and model/serial number ready. The model/serial number information can be found on the back of your unit.
- Call 1-877-300-8837 or visit www.TCLUSA/SUPPORT
- A representative must troubleshoot your problem over the telephone or through e-mail before receiving service. If it is determined that your unit requires service, the service location will be at the sole discretion of TTE based upon the TTE Limited Warranty Statement.
- At the sole discretion of TTE, television screen sizes 40" and smaller will either be repaired at an Authorized TCL Service Center or directly exchanged for a new or refurbished/remanufactured unit. At the sole discretion of TTE, television screen sizes 41" through 65" or larger will either be repaired at an Authorized TCL Service Center or repaired in-home.
- If repaired at an Authorized TCL Service Center, TTE is not responsible for transportation costs to the Authorized TCL Service Center. However, TTE will pay for return shipping. TTE will provide instructions for packaging and shipping the unit. **Units that are improperly packed and damaged during shipping are not covered under your product warranty.**
- Proof of purchase in the form of a bill of sale or receipted invoice from an Authorized Dealer which is evidence that the product is within the warranty period must be presented to obtain warranty service.
- In the event that a unit is to be replaced, a picture of the back of the unit showing the model and serial number and picture of the issue itself may be required.
- PRE-AUTHORIZATION MUST BE OBTAINED BEFORE (1) SENDING ANY PRODUCT TO AN AUTHORIZED TCL SERVICE CENTER, OR (2) OBTAINING ANY IN-HOME REPAIR/REPLACEMENT/ RENTAL SERVICES.

What your warranty does not cover

- **A unit sold in "As-Is", "Used", "Factory Reconditioned", "Factory Re-Certified", or "Refurbished", condition or with faults.**
- Units physically broken during shipment from a Retailer. Please contact your Retailer for assistance.
- Extended Service Plans purchased from Retailers. Please contact your Retailer for assistance.
- Customer instruction. (Your Owner's Manual describes how to install, adjust, and operate your unit. Any additional information should be obtained from your Authorized Dealer).
- Installation and related adjustments, or damage resulting from installation.
- Damage resulting from non-approved installation methods.
- Signal reception problems not caused by your unit.
- Damage from misuse, abuse, neglect, normal wear and tear, cosmetic damage, mishandling, faulty installation, or power line surges.
- Markings or images on the television's panel resulting from viewing fixed images (including but not limited to certain 4:3 images on wide screen televisions, or data or images in fixed screen locations from banners, video games, or certain broadcast networks).
- Batteries.
- A television that has been modified or incorporated into other products.
- A unit purchased or serviced outside the USA.
- Acts of nature or God, such as but not limited to earthquake or lightning damage.
- Special, incidental or consequential damages.

LIMITATION OF WARRANTY

- THE WARRANTY STATED ABOVE IS THE ONLY WARRANTY APPLICABLE TO THIS PRODUCT. NO VERBAL OR WRITTEN INFORMATION GIVEN BY TTE TECHNOLOGY, INC., ITS AGENTS OR EMPLOYEES SHALL CREATE A GUARANTY OR IN ANY WAY INCREASE OR MODIFY THE SCOPE OF THIS WARRANTY.
- REPAIR OR REPLACEMENT AS PROVIDED UNDER THIS WARRANTY IS THE EXCLUSIVE REMEDY OF THE CONSUMER. TTE TECHNOLOGY, INC. SHALL NOT BE LIABLE FOR SPECIAL, INCIDENTAL, OR CONSEQUENTIAL DAMAGES RESULTING FROM THE USE OF THIS PRODUCT OR ARISING OUT OF ANY BREACH OF ANY EXPRESS OR IMPLIED WARRANTY ON THIS PRODUCT. THIS DISCLAIMER OF WARRANTIES AND LIMITED WARRANTY ARE GOVERNED BY THE LAWS OF THE STATE OF CALIFORNIA. EXCEPT TO THE EXTENT PROHIBITED BY APPLICABLE LAW, ANY IMPLIED WARRANTY OF MERCHANTABILITY OR FITNESS FOR A PARTICULAR PURPOSE ON THIS PRODUCT IS LIMITED TO THE APPLICABLE WARRANTY AND WARRANTY PERIOD SET FORTH ABOVE. THIS WARRANTY IS SUBJECT TO CHANGE WITHOUT NOTICE. PLEASE VISIT WWW.TCLUSA.COM TO VIEW THE MOST CURRENT VERSION.

How State Law relates to this warranty

- Some states do not allow the exclusion or limitation of incidental or consequential damages, or limitations on how long an implied warranty lasts, so the above limitations or exclusions may not apply to you.
- This warranty gives you specific legal rights, and you also may have other rights that vary from state to state.

If you purchased your unit outside the United States or seek warranty coverage outside the United States: This warranty does not apply. Contact your dealer for warranty information.

Service calls which do not involve defective materials or workmanship are not covered by this warranty. Costs of such service calls are the sole responsibility of the purchaser.

Legal statement

Please note—Use of the TCL Roku TV is governed by the TCL Roku TV End User Agreement (see below). In addition, an end user online profile and billing account with Roku, Inc. (“Roku”) on Roku’s website (“Roku Account”) is required to stream content via the Internet using your TCL Roku TV. A Roku Account gives you access to movies, television shows, and other audio-visual entertainment in the “Roku Channel Store,” a storefront of applications provided by Roku via your device’s on-screen menu. After your Roku Account is created, you can link your TCL Roku TV to your account. By using the TCL Roku TV, you agree to the following disclaimer. For the avoidance of doubt, the content disclaimer set forth herein shall refer to all content and channels accessible and available on the TCL Roku TV, including those available via the Roku® streaming platform, as well as broadcast cable.

Due to the various capabilities of the TCL Roku TV, as well as limitations in the available content available therein, certain features, applications, and services may not be available on all TCL Roku TV s, or in all territories. Some features on the TCL Roku TV may also require additional peripheral devices or membership fees that are sold separately. Please visit the TCL Roku TV or Roku, Inc. websites for more information on the TCL Roku TV and content availability. The services and availability of content on the TCL Roku TV are subject to change from time to time without prior notice.

All content and services accessible through the TCL Roku TV belong to third parties and are protected by copyright, patent, trademark and/or other intellectual property laws. Such content and services are provided solely for your personal noncommercial use. You may not use any content or services in a manner that has not been authorized by the content owner or service provider. Without limiting the foregoing, you may not modify, copy, republish, upload, post, transmit, translate, sell, create derivative works, exploit, or distribute in any manner or medium any content or services displayed through the TCL Roku TV.

You expressly acknowledge and agree that your use of the TCL Roku TV is at your sole risk and that the entire risk as to satisfactory quality, performance and accuracy is with you. The TCL Roku TV and all third party content and services are provided “as is” without warranty of any kind, either express or implied. TCL Roku TV and Roku expressly disclaims all warranties and conditions with respect to the TCL Roku TV content and services, either express or, implied, including but not limited to, warranties of merchantability, of satisfactory quality, fitness for a particular purpose, of accuracy, of quiet enjoyment, and non-infringement of third party rights. [[Company]] and Roku do not guarantee the accuracy, validity, timeliness, legality, or completeness of any content or service made available through the TCL Roku TV and does not warrant that the TCL Roku TV, content or services will meet your requirements, or that operation of the TCL Roku TV will be uninterrupted or error-free. Under no circumstances, including negligence, shall [[Company]] or Roku be liable, whether in contract or tort, for any direct, indirect, incidental, special or consequential damages, attorney fees, expenses, or any other damages arising out of, or in connection with, any information contained in, or as a result of the use of the device, or any content or service accessed by you or any third party, even if advised of the possibility of such damages.

Third party services may be changed, suspended, removed, terminated or interrupted, or access may be disabled at any time, without notice, and [[Company]] and Roku makes no representation or warranty that any content or service will remain available for any period of time. Content and services are transmitted by third parties by means of networks and transmission facilities over which [[Company]] and Roku have no control. Without limiting the generality of this disclaimer, [[Company]] and Roku expressly disclaims any responsibility or liability for any change, interruption, disabling, removal of or suspension of any content or service made available through the TCL Roku TV. [[Company]], Roku, the content providers, or the service providers may impose limits on the use of or access to certain services or content, in any case and without notice or liability. Any questions or requests for service relating to the content or services made available on the TCL Roku TV should be submitted to the respective cable content or service provider or as described in the TCL Roku TV User Guide.

In the event of a conflict between the TCL Roku TV End User Agreement and the terms set forth in this Legal Disclaimer, the TCL Roku TV End User Agreement shall prevail and control in all circumstances.

END USER LICENSE AGREEMENT (FOR ROKU TV)

IMPORTANT: READ THIS AGREEMENT CAREFULLY BEFORE YOU USE A ROKU TV. ALSO REVIEW THE IMPORTANT PRODUCT INFORMATION THAT MAY HAVE BEEN PROVIDED WITH YOUR ROKU TV.

Overview

This End User License Agreement (“EULA”) between you and Roku, Inc. (“Roku”) governs the use of: (a) your television which uses the Roku platform to play digital content over the Internet (“Television”), and (b) any firmware and software that have been pre-installed on the Television and the firmware and software updates Roku provides to you for the Television (collectively, the “Software”). By linking the Television to your account on Roku’s website (“Roku Account”) or using the Television, you are agreeing to this EULA. If you are a resident of the European Economic Area, by agreeing to this EULA, you expressly agree to waive your right to withdraw.

If you do not agree to this EULA, you do not have the right to use the Television or the Software. If you are within the allowable time period for returns under the applicable return policy, you may return the Television to your seller for a refund, subject to the terms of such return policy. You should perform a factory reset before you return it to erase data that may be stored on the Television. For instructions on how to reset your Television, please visit www.roku.com/support.

In this EULA, “Channel” means an application in the Roku Channel Store; “Content” means movies, television shows, music and other audio and visual materials and entertainment; “Content Provider” means any provider of Content; and “Roku Channel Store” means the storefront of applications provided by Roku via the Television’s on-screen menu.

Changes to This EULA

Roku may amend this EULA at any time in its discretion. Such amendments shall be effective immediately upon posting of the amended EULA on Roku's website or via the Television or your Roku Account, whichever occurs first. If you have a Roku Account that is linked to your Television, then in its option, Roku may also notify you of the amended EULA by sending a notice to the last email address you have provided to Roku. You agree to provide accurate and complete information if and when you set up your Roku Account, and you agree to promptly update your account information (including contact information) to keep it accurate and complete. You can do this at any time by signing in to your Roku Account. Following such posting or notice by any of the methods described above, continued use of your Television or Roku Account means you accept and agree to the amended EULA. If you do not agree to the amended EULA, Roku may not be able to provide updates, upgrades or enhancements to your Television, and you may not be able to continue using your Television or Roku Account.

Permitted Use and Restrictions

The Television and the Software are for personal, non-commercial use only. Copying or redistribution of any Content delivered via the Television is strictly prohibited and we may prevent or restrict you from copying or re-distributing any elements of the Software or Content using digital rights management or other technologies. The Television and the Software are for use only in those countries where the manufacturer of your Television has authorized its sale. If you are using the Television and the Software outside of these countries, the rights granted under this EULA do not apply. Some of the Content Providers use technologies to verify your geographic location, and you may not be able to use the Television or the Software to access any Content outside of the country or location authorized by Roku or the Content Provider. Except as expressly provided under this EULA, you do not acquire any intellectual property or other proprietary rights in or to the Television, the Software or the Content, including any rights in patents, inventions, improvements, designs, trademarks, database rights or copyrights, nor do you acquire any rights in any confidential information or trade-secrets. All rights not expressly granted to you in this EULA are reserved by Roku or its applicable licensors. You may not remove, obscure, alter or conceal any trademark, logo, copyright or other proprietary notice in or on any Television, Software or Content.

The Software is proprietary to Roku or its third party licensors and may be used only with the Television. Subject to this EULA and, where appropriate, the applicable third party licenses, you have a non-exclusive, non-transferable license to run the Software and any updated versions provided to you by Roku, only in and as incorporated in the Television. This is a license and not a sale. You may not (a) copy, assign, sublicense, lease, sell or rent the Software, (b) distribute or otherwise transfer the Software except as incorporated in the Television, provided that, you do not retain any copies of the Software and the recipient reads and agrees to this EULA (including all amendments); (c) modify, adapt, translate, or create derivative works of the Software (except only to the extent any of the foregoing restriction is prohibited by applicable law or as may be permitted by the license terms governing any Separately Licensed Code included with the Software); (d) decompile, disassemble, reverse engineer or otherwise derive source code from the Software, except to the extent such actions cannot be prohibited under applicable law because they are essential to achieve inter-operability of the Software with another software program, and provided that the information obtained by you during such activities is (i) used only to achieve such inter-operability; (ii) not disclosed without Roku's prior written consent; and (iii) not used to create any software that is substantially similar to the Software; (e) defeat, bypass, circumvent or interfere with any security mechanism or access control measures, or (f) have any of the foregoing done for you by a third party. This license does not include the right to receive Software upgrades or updates. Your right to use the Television and the Software will immediately terminate upon your breach of this EULA.

Software Updates

IN ITS SOLE DISCRETION, ROKU MAY PROVIDE UPDATES TO YOUR TELEVISION VIA THE INTERNET, INCLUDING BUG FIXES AND UPDATES, CHANGES IN THE USER INTERFACE OR HOW YOU ACCESS CONTENT, AND OTHER CHANGES THAT MAY ADD, ALTER OR REMOVE FUNCTIONALITIES AND FEATURES. YOU ACKNOWLEDGE THAT THESE UPDATES: (A) MAY HAPPEN AUTOMATICALLY IN THE BACKGROUND AT ANY TIME (AND THAT THEY CANNOT BE DISABLED BY YOU); AND (B) WILL REQUIRE AN INTERNET CONNECTION AND YOU MAY INCUR ADDITIONAL DATA CHARGES FROM THE PROVIDER OF THE INTERNET CONNECTION. YOU UNDERSTAND THAT THESE UPDATES ARE NECESSARY TO MAINTAIN COMPATIBILITY WITH OTHER UPDATES TO ROKU'S PRODUCTS OR SERVICES AND MAY BE REQUIRED FOR SECURITY REASONS. BY USING THE TELEVISION, YOU HEREBY AGREE TO RECEIVE SUCH UPDATES.

Separately Licensed Code

Certain software components of the Software are provided under separate third party license terms ("**Separately Licensed Code**") and your right to use such components is governed by such license terms. Please visit <https://www.roku.com/separatelylicensedcode> for more information.

Voice Search

If downloaded to your phone or mobile device, the Roku mobile app allows you to use your voice to search for content on your Television using voice search. When you choose to use voice search, you agree that Roku and/or a third party vendor contracted by Roku have your consent to record, process and store your voice inputs (e.g., a recording and the interpretation of what was said), and use such voice inputs with other information about your Television (e.g., device identifier) to provide services related to voice search to you, to improve the accuracy and quality of the service, and as described in Roku's Privacy Policy. To learn more about voice search, visit the FAQ pages of Roku's website at www.roku.com/support.

NO WARRANTY FROM ROKU; Limitation of LIABILITY

YOUR warranty with respect to the Television is provided by THE TELEVISION'S MANUFACTURER, and not by Roku. ROKU OFFERS NO WARRANTY TO YOU UNDER THIS EULA. WITHOUT LIMITING THE GENERALITY OF THE FOREGOING DISCLAIMER, TO THE MAXIMUM EXTENT PERMITTED BY APPLICABLE LAW:

- (A) THE SEPARATELY LICENSED CODE AND THE SOFTWARE ARE PROVIDED "AS IS", WITH ALL FAULTS AND WITHOUT WARRANTY OF ANY KIND. ROKU DISCLAIMS ALL OTHER WARRANTIES AND CONDITIONS, INCLUDING THE IMPLIED WARRANTY OF MERCHANTABILITY,

SATISFACTORY QUALITY, FITNESS FOR A PARTICULAR PURPOSE AND NON-INFRINGEMENT. ROKU DOES NOT GUARANTEE, REPRESENT, OR WARRANT THAT THE TELEVISION, THE SEPARATELY LICENSED CODE AND THE SOFTWARE WILL BE: (I) SECURE, VIRUS-FREE OR ERROR-FREE, OR (II) FREE FROM ATTACK OR SECURITY INTRUSION.

- (B) IN NO EVENT SHALL ROKU, ITS DIRECTORS, OFFICERS OR EMPLOYEES BE LIABLE TO YOU FOR PERSONAL INJURY OR PROPERTY DAMAGE, OR ANY SPECIAL, INCIDENTAL, EXEMPLARY, PUNITIVE, INDIRECT OR CONSEQUENTIAL DAMAGES OF ANY KIND ARISING OUT OF ANY TELEVISION, THE SEPARATELY LICENSED CODE, THE SOFTWARE, OR YOUR USE THEREOF; AND
- (C) YOU AGREE THAT (I) THE TOTAL CUMULATIVE LIABILITY OF ROKU, ITS DIRECTORS, OFFICERS AND EMPLOYEES UNDER THIS EULA, INCLUDING LIABILITY RELATING TO ALL TELEVISIONS LINKED TO YOUR ROKU ACCOUNT, AND THE SEPARATELY LICENSED CODE AND THE SOFTWARE IN SUCH TELEVISIONS, AND YOUR USE THEREOF, SHALL NOT EXCEED THE AMOUNT SET FORTH IN THE ROKU ACCOUNT TERMS AND CONDITIONS YOU AGREED TO FOR YOUR ROKU ACCOUNT, AND (II) ROKU, ITS DIRECTORS, OFFICERS AND EMPLOYEES SHALL NOT BE LIABLE TO YOU UNDER THIS EULA FOR ANY DIRECT DAMAGES ARISING OUT OF, OR IN CONNECTION WITH THE TELEVISION. THE FOREGOING LIMITATIONS SHALL APPLY EVEN IF THE REMEDY PROVIDED HEREIN FAILS ITS ESSENTIAL PURPOSE AND EVEN IF ROKU, ITS DIRECTORS, OFFICERS OR EMPLOYEES HAVE BEEN ADVISED OF THE POSSIBILITY OF SUCH LIABILITY.

SOME JURISDICTIONS DO NOT ALLOW EXCLUSIONS OF CERTAIN WARRANTIES OR LIMITATIONS OF LIABILITY FOR CERTAIN TYPES OF DAMAGES, SO SOME OF THE ABOVE LIMITATIONS IN THIS SECTION MAY NOT APPLY TO YOU. NOTHING IN THESE TERMS OF USE SHALL AFFECT ANY NON-WAIVABLE STATUTORY RIGHTS THAT APPLY TO YOU, AND YOU MAY ALSO HAVE OTHER RIGHTS THAT VARY FROM JURISDICTION TO JURISDICTION.

Export Controls

You agree not to download any Content or Software, nor otherwise export or re-export any Television or the Software into (or to a national or resident of) Cuba, Iraq, Libya, North Korea, Iran, Syria or any other country as to which the United States or your country has embargoed goods, or to anyone on the U.S. Treasury Department's List of Specially Designated Nationals or the U.S. Commerce Department's Table of Denial Orders or on similar restricted lists published by your government from time to time. By using any Television or the Software, you are representing and warranting that you are not located in, under the control of, or a national or resident of any such country or on any such list.

Choice of Law; Dispute Resolution

- A. If you are a consumer and a resident in any country in the European Economic Area where the sale of the Television is expressly authorized by its manufacturer, this EULA does not apply to you.
- B. In all other cases, including if you are a resident of the United States (and its possessions and territories) or Canada, you agree that this EULA shall be governed by the laws of the State of California without regard to any conflict of laws principles that may provide the application of the law of another jurisdiction; and:
 - 1. You and Roku agree to be bound by the procedures set forth below to resolve any and all claims between you and Roku arising out of or relating to any aspect of this EULA, whether based in contract, tort, statute, fraud, misrepresentation or any other legal theory, including but not limited to, claims between you and Roku related to the Television and the Software. Each such claim is referred to individually as “Claim” and collectively as “Claims”.
 - 2. **YOU AND ROKU AGREE THAT, EXCEPT FOR THE CLAIMS IDENTIFIED IN PARAGRAPH 4 OF THIS SECTION BELOW, ANY AND ALL CLAIMS BETWEEN YOU AND ROKU SHALL BE FINALLY SETTLED BY BINDING ARBITRATION.** The arbitration shall take place in Santa Clara County, California and shall be administered by the American Arbitration Association (“AAA”) pursuant to the AAA’s then-current rules, including (if applicable) the AAA’s Supplementary Procedures for Consumer-Related Disputes. Please be aware there is no judge or jury in arbitration. Arbitration procedures are simpler and more limited than the rules applicable in court, and review of the arbitrator’s decision by a court is limited. **YOU AND ROKU FURTHER AGREE THAT EACH OF YOU MAY BRING CLAIMS AGAINST THE OTHER ONLY ON AN INDIVIDUAL BASIS AND NOT AS A PLAINTIFF OR CLASS MEMBER IN ANY PURPORTED CLASS OR REPRESENTATIVE ACTION OR PROCEEDING. THE ARBITRATOR MAY NOT CONSOLIDATE OR JOIN MORE THAN ONE PERSON’S CLAIM AND MAY NOT PRESIDE OVER ANY CONSOLIDATED, REPRESENTATIVE OR CLASS PROCEEDING. ALSO, THE ARBITRATOR MAY AWARD RELIEF (INCLUDING MONETARY, INJUNCTIVE OR DECLARATORY RELIEF) ONLY ON AN INDIVIDUAL BASIS AND MAY NOT AWARD ANY FORM OF CONSOLIDATED, REPRESENTATIVE OR CLASS-WIDE RELIEF.** Notwithstanding any provision in these terms to the contrary, if the class-action waiver in this provision is deemed invalid or unenforceable, or if an arbitration is allowed to proceed on a class basis, then neither you nor Roku are entitled to arbitrate the Claims. This arbitration provision is subject to the Federal Arbitration Act. The arbitrator’s award shall be binding on you and Roku, and may be entered in any court of competent jurisdiction.
 - 3. Information on AAA and how arbitration is initiated can be found at www.adr.org or by calling 800-778-7879. For Claims between You and Roku of \$75,000 or less, you will be responsible for the initial arbitration filing fee, up to the amount of the initial filing fee if you were to initiate a lawsuit against Roku based on such Claims in court. If the arbitrator finds such Claims to be non-frivolous, Roku will pay any difference in such filing fees plus the arbitrator fees. For Claims between You and Roku in excess of \$75,000, if you are able to demonstrate that the costs of arbitration will be prohibitive as compared to the costs of litigation, Roku will pay as much of your actual filing fees and the arbitrator fees for the arbitration as the arbitrator deems necessary to prevent the arbitration from being cost-prohibitive as compared to the cost of litigation.
 - 4. This agreement to arbitrate does not apply to any Claim (a) in which a party is attempting to protect its intellectual property rights (such as its patent, copyright, trademark, trade secret, or moral rights, but not including its privacy or publicity rights), or (b) that may be brought in small-claims court.

5. If the agreement to arbitrate in this provision is found to be invalid, unenforceable or inapplicable to a given Claim between You and Roku, then any and all proceedings to resolve such Claim must be brought exclusively in a federal court of competent jurisdiction in the Northern District of California or in a state court in Santa Clara County, California. You hereby irrevocably consent to the exclusive jurisdiction and venue of such courts.
6. **30-Day Right to Opt Out:** You have the right to opt out of this agreement to arbitrate by sending a written notice of your decision to opt out to the following address: Legal Department, Roku, Inc., 12980 Saratoga Avenue, Saratoga, California 95070, USA; provided that, such notice must be postmarked on or before the 30th day after the first to occur of the following events if you do not already have a Roku Account: (a) the date of purchase of Your Television, or (b) the date you create your Roku Account. If you have an existing Roku Account, all devices you choose to link to your Roku Account, and all services provided by Roku which are accessed using these devices, will be subject to this agreement to arbitrate. Your notice should include your full name, your current postal address, telephone number and email address, the product name and serial number for Your Television, and a copy of the original proof of purchase for your Television. If you timely send a notice in compliance with this paragraph 6, the agreement to arbitrate will not apply to either you or Roku. If you do not timely send this notice, then you agree to be bound by this agreement to arbitrate.
7. Notwithstanding any provision in this Agreement to the contrary, you agree that, if Roku seeks to delete or materially modify the agreement to arbitrate described herein, any such deletion or modification will not apply to any individual Claim of which you have notified Roku prior to such modification.

Miscellaneous

Roku may transfer its rights and obligations under this EULA to another organization. You may only transfer your rights or your obligations under this EULA to another person if Roku agrees in writing. This EULA is between you and Roku. No other person shall have any rights to enforce these terms. Each of the paragraphs of this EULA operates separately. If any court or relevant authority decides that any of them are unlawful, the remaining paragraphs will remain in full force and effect. If Roku fails to insist that you perform any of your obligations under this EULA, or if Roku does not enforce its rights against you, or if Roku delays in doing so, that will not mean that Roku has waived its rights against you, or that you do not have to comply with those obligations. If Roku does waive a default by you, Roku will only do so in writing, but that will not mean that Roku will automatically waive any later default by you.

Contact Information

If you wish to contact Roku, please send your correspondence by mail to

Roku, Inc.
12980 Saratoga Avenue
Saratoga, CA 95070, USA

or by email to customerservice@roku.com.

Last Updated: October 20, 2015

CONTRAT DE LICENCE D'UTILISATEUR FINAL (POUR ROKU TV)

IMPORTANT : LIRE ATTENTIVEMENT CE CONTRAT AVANT D'UTILISER UN TÉLÉVISEUR ROKU TV. PASSER ÉGALEMENT EN REVUE LES RENSEIGNEMENTS IMPORTANTS RELATIFS AU PRODUIT QUI PEUVENT AVOIR ÉTÉ FOURNIS AVEC VOTRE TÉLÉVISEUR ROKU TV.

Aperçu

Le présent contrat de licence d'utilisateur final (« **CLUF** ») conclu entre vous et Roku, Inc. (« **Roku** ») régit l'utilisation de : (a) votre téléviseur qui se sert de la plateforme Roku pour lire du contenu numérique sur Internet (« **Téléviseur** ») et (b) tous les microprogrammes et logiciels qui ont été préinstallés sur le Téléviseur, ainsi que les mises à jour des microprogrammes et logiciels que Roku met à votre disposition pour le Téléviseur (collectivement le « **Logiciel** »). Lier le Téléviseur à votre compte sur le site Web de Roku (« **Compte Roku** ») ou utiliser le Téléviseur signifie que vous acceptez ce CLUF. Si vous résidez sur le territoire économique européen et acceptez ce CLUF, vous acceptez expressément de renoncer à votre droit de rétractation.

Si vous n'acceptez pas le présent CLUF, vous ne pouvez pas utiliser le Téléviseur ni le Logiciel. Si le délai autorisé pour les retours n'est toujours pas échu en vertu de la politique de retour applicable, vous pouvez retourner le Téléviseur à votre vendeur pour obtenir un remboursement, sous réserve des modalités d'une telle politique de retour. Vous devez effectuer une réinitialisation d'usine avant de retourner l'appareil afin d'effacer les données pouvant être stockées sur le Téléviseur. Pour obtenir des renseignements sur la façon de réinitialiser votre Téléviseur, veuillez visiter la page www.roku.com/support.

Dans le présent CLUF, « **Canal** » désigne une application de la boutique de canaux Roku; « **Contenu** » désigne des films, des séries télévisées, de la musique et tout autre contenu et divertissement audiovisuel; « **Fournisseur de contenu** » désigne tout fournisseur de Contenu et « **Boutique de canaux Roku** » désigne la vitrine d'applications fournies par Roku par l'intermédiaire du menu à l'écran du Téléviseur.

Modifications au présent CLUF

Roku peut modifier ce CLUF à tout moment à sa discrétion. Ces modifications entreront en vigueur immédiatement après la publication du CLUF modifié sur le site Web de Roku, le Téléviseur ou votre compte Roku, selon la première éventualité. Si vous disposez d'un compte Roku

associé à votre Téléviseur, Roku peut également, à sa discrétion, vous informer du CLUF modifié en envoyant un avis à la dernière adresse électronique que vous avez indiqué à Roku. Vous acceptez de fournir des renseignements exacts et complets lorsque vous configurez votre compte Roku et vous vous engagez à mettre rapidement à jour les renseignements de votre compte, y compris vos coordonnées, afin qu'ils soient exacts et complets. Vous pouvez le faire à tout moment en vous connectant à votre compte Roku. À la suite d'une telle annonce ou d'un tel avis par l'une des méthodes décrites ci-dessus, continuer à utiliser votre Téléviseur ou votre compte Roku signifie que vous acceptez le CLUF modifié. Si vous n'acceptez pas le CLUF modifié, Roku ne sera peut-être pas en mesure de fournir des mises à jour, des mises à niveau ou des améliorations pour votre Téléviseur, et vous pourriez ne plus être en mesure de continuer à utiliser votre Téléviseur ou votre compte Roku.

Utilisation autorisée et restrictions

Le Téléviseur et le Logiciel sont destinés à un usage personnel et non commercial uniquement. Toute reproduction ou toute redistribution du contenu offert par le Téléviseur est strictement interdite et nous pourrions vous empêcher de copier ou de redistribuer tout élément du Logiciel ou du contenu à l'aide d'un système de gestion des droits numériques ou d'autres technologies. Le Téléviseur et le Logiciel sont uniquement destinés à une utilisation dans les pays dans lesquels le fabricant de votre Téléviseur a autorisé leur vente. Si vous utilisez le Téléviseur et le Logiciel en dehors de ces pays, les droits accordés en vertu du présent CLUF ne s'appliquent pas. Certains des Fournisseurs de contenu utilisent des technologies qui permettent de vérifier votre situation géographique et vous pourriez ne pas être en mesure d'utiliser le Téléviseur ou le Logiciel pour accéder au Contenu en dehors du pays ou de l'emplacement autorisé par Roku ou le Fournisseur de contenu. Sauf dans la mesure expressément indiquée dans le présent CLUF, vous n'acquièrez aucune propriété intellectuelle ou aucun autre droit de propriété de quelque nature sur le Téléviseur, le Logiciel ou le Contenu, y compris les droits de brevets, les inventions, les améliorations, les conceptions, les marques, les droits de base de données ou les droits d'auteur, et vous n'acquièrez aucun droit sur tout renseignement confidentiel ou secret commercial. Tous les droits qui vous ne sont pas expressément concédés dans le présent CLUF sont réservés par Roku ou ses concédants de licence applicables. Vous ne pouvez pas supprimer, obscurcir, modifier ou dissimuler toute marque, tout logo, tout droit d'auteur ou toute autre mention de droit de propriété dans ou sur n'importe quel Téléviseur, Logiciel ou Contenu.

Le Logiciel est la propriété de Roku ou d'une tierce partie licenciée et peut être utilisé uniquement avec le Téléviseur. Sous réserve du présent CLUF et, le cas échéant, des licences applicables de tiers, vous détenez une licence non exclusive et non transférable d'utilisation du Logiciel et de toute version mise à jour qui vous est fournie par Roku, seulement dans le Téléviseur et sous la forme qu'il incorpore. Ceci constitue une licence et non une vente. Vous ne pouvez pas (a) copier, céder, louer ou vendre le Logiciel ou accorder une sous-licence pour ce dernier; (b) distribuer ou autrement transférer le Logiciel, sauf comme incorporé dans le Téléviseur, pourvu que vous ne conserviez aucune copie du Logiciel et que le destinataire lit et s'engage à respecter cet accord de licence (y compris tous les amendements); (c) modifier, adapter, traduire ou créer des œuvres dérivées du Logiciel (sauf dans la mesure où toute restriction qui précède est interdite par la loi applicable ou jugée

acceptable par les termes de la licence régissant tout code utilisé avec autorisation fourni avec le Logiciel); (d) décompiler, désassembler, désosser ou autrement extraire le code source du Logiciel, sauf dans la mesure où ces gestes ne peuvent être interdits en vertu de la loi applicable parce qu'ils sont essentiels à l'interopérabilité du Logiciel avec un autre logiciel, et pourvu que les renseignements obtenus par vous au cours de ces activités sont (i) utilisés uniquement pour réaliser cette interopérabilité; (ii) non divulgués sans le consentement écrit de Roku obtenu préalablement; et (iii) ne sont pas utilisés pour créer un logiciel qui est substantiellement similaire au Logiciel; (e) usurper, contourner ou gêner tout mécanisme de sécurité ou toute mesure de contrôle d'accès, ou (f) faire effectuer ce qui précède pour vous par un tiers. Cette licence n'inclut pas le droit de recevoir des mises à jour ou des mises à niveau logicielles. Votre droit d'utiliser le Téléviseur et le Logiciel sera immédiatement annulé sur violation du présent CLUF.

Mises à jour logicielles

À SA SEULE DISCRÉTION, ROKU PEUT FOURNIR DES MISES À JOUR SUR VOTRE TÉLÉVISEUR PAR INTERNET, Y COMPRIS DES CORRECTIFS, DES MISES À JOUR, DES MODIFICATIONS DE L'INTERFACE OU DE LA MANIÈRE D'ACCÉDER AU CONTENU, ET D'AUTRES CHANGEMENTS QUI PEUVENT AJOUTER, ALTÉRER OU SUPPRIMER DES FONCTIONNALITÉS ET DES CARACTÉRISTIQUES. VOUS RECONNAISSEZ QUE CES MISES À JOUR (A) PEUVENT SE PRODUIRE AUTOMATIQUÉMENT EN ARRIÈRE-PLAN À TOUT MOMENT (ET QU'ELLES NE PEUVENT PAS ÊTRE DÉSACTIVÉES PAR VOUS); ET (B) NÉCESSITENT UNE CONNEXION INTERNET ET QUE VOUS POURRIEZ DEVOIR PAYER DES FRAIS DE DONNÉES SUPPLÉMENTAIRES À VOTRE FOURNISSEUR DE CONNEXION INTERNET. VOUS COMPRENEZ QUE CES MISES À JOUR SONT NÉCESSAIRES POUR MAINTENIR LA COMPATIBILITÉ AVEC LES AUTRES MISES À JOUR DE PRODUITS OU DE SERVICES DE ROKU ET QU'ELLES PEUVENT ÊTRE NÉCESSAIRES POUR DES RAISONS DE SÉCURITÉ. EN UTILISANT LE TÉLÉVISEUR, VOUS ACCEPTEZ DE RECEVOIR CES MISES À JOUR.

Code sous licence distincte

Certains composants du Logiciel sont fournis sous les termes distincts de licence de tiers (« **Code sous licence distincte** ») et votre droit d'utiliser ces composants est régi par les modalités de cette licence. Veuillez visiter le <https://www.roku.com/separatelylicensedcode> pour obtenir de plus amples renseignements.

Recherche vocale

Si vous la téléchargez sur votre téléphone ou appareil mobile, l'application mobile Roku vous permet d'utiliser votre voix et la recherche vocale pour chercher du contenu sur votre Téléviseur. Lorsque vous choisissez d'utiliser la recherche vocale, vous acceptez que Roku et/ou un fournisseur tiers fournisseur engagé par Roku aient votre consentement pour enregistrer, traiter et stocker vos entrées vocales (par exemple, un enregistrement et l'interprétation de ce qui a été dit) et utilisent ces entrées vocales avec d'autres renseignements sur votre Téléviseur (par exemple, identificateur de périphérique) pour fournir des services liés à la recherche vocale pour vous afin d'améliorer la précision et la qualité du service, comme cela est décrit dans la politique de confidentialité de Roku. Pour en savoir plus sur la recherche vocale, visitez les pages de FAQ du site de Roku au www.roku.com/support.

AUCUNE GARANTIE DE LA PART DE ROKU; LIMITATION DE RESPONSABILITÉ

VOTRE GARANTIE RELATIVE AU TÉLÉVISEUR EST FOURNIE PAR LE FABRICANT DU TÉLÉVISEUR ET NON PAS PAR ROKU. ROKU NE VOUS OFFRE AUCUNE GARANTIE EN VERTU DU PRÉSENT CLUF. SANS RESTREINDRE LA PORTÉE GÉNÉRALE DU PRÉSENT AVIS DE NON-RESPONSABILITÉ, DANS LES LIMITES PERMISES PAR LES LOIS APPLICABLES :

- (A) LE CODE SOUS LICENCE DISTINCTE ET LE LOGICIEL SONT FOURNIS « TELS QUELS », ERREURS COMPRISES, SANS GARANTIE D'AUCUNE SORTE. ROKU RENONCE À TOUTES LES AUTRES GARANTIES ET CONDITIONS, Y COMPRIS LA GARANTIE IMPLICITE DE QUALITÉ MARCHANDE, DE QUALITÉ SATISFAISANTE, D'ADÉQUATION À UN USAGE PARTICULIER ET D'ABSENCE DE CONTREFAÇON. ROKU NE PEUT GARANTIR, DÉCLARER NI CERTIFIER QUE LE TÉLÉVISEUR, LE CODE SOUS LICENCE DISTINCTE ET LE LOGICIEL SERONT : (I) SÉCURISÉS, SANS VIRUS OU SANS ERREUR, OU (II) DÉNUÉS DE TOUTE ATTAQUE OU INTRUSION DE SÉCURITÉ.
- (B) EN AUCUN CAS ROKU, SES ADMINISTRATEURS, SES DIRIGEANTS OU SES EMPLOYÉS NE SERONT RESPONSABLES ENVERS VOUS POUR TOUTE LÉSION CORPORELLE OU TOUT DOMMAGE MATÉRIEL, OU TOUT DOMMAGE PARTICULIER, ACCESSOIRE, EXEMPLAIRE, PUNITIF, INDIRECT OU IMMATÉRIEL DE QUELQUE NATURE DÉCOULANT DE TOUT TÉLÉVISEUR, CODE SOUS LICENCE DISTINCTE, LOGICIEL OU DE VOTRE UTILISATION DE CEUX-CI; ET
- (C) VOUS ACCEPTEZ QUE (I) LA RESPONSABILITÉ CUMULATIVE DE ROKU, DE SES ADMINISTRATEURS, SES DIRIGEANTS OU SES EMPLOYÉS, EN VERTU DU PRÉSENT CLUF, NOTAMMENT SA RESPONSABILITÉ CONCERNANT TOUS LES TÉLÉVISEURS ASSOCIÉS À VOTRE COMPTE ROKU, AINSI QUE LE CODE SOUS LICENCE DISTINCTE ET LE LOGICIEL INSTALLÉ SUR DE TELS TÉLÉVISEURS, ET VOTRE UTILISATION DE CEUX-CI, NE DÉPASSERA PAS LE MONTANT SPÉCIFIÉ DANS LES CONDITIONS GÉNÉRALES DU COMPTE ROKU QUE VOUS AVEZ ACCEPTÉES POUR VOTRE COMPTE ROKU, ET QUE (II) ROKU, SES ADMINISTRATEURS, SES DIRIGEANTS ET SES EMPLOYÉS NE SERONT PAS RESPONSABLES ENVERS VOUS, EN VERTU DU PRÉSENT CLUF, POUR LES DOMMAGES DIRECTS DÉCOULANT DU TÉLÉVISEUR OU EN LIEN AVEC CELUI-CI. LES LIMITATIONS CI-DESSUS S'APPLIQUENT MÊME SI LE RECOURS PRÉVU AUX PRÉSENTES ÉCHOUÉ DANS SON OBJECTIF PRINCIPAL ET MÊME SI ROKU, SES ADMINISTRATEURS, DIRIGEANTS OU SES EMPLOYÉS ONT ÉTÉ AVISÉS DE LA POSSIBILITÉ D'UNE TELLE RESPONSABILITÉ.

CERTAINS TERRITOIRES N'AUTORISENT PAS L'EXCLUSION DE CERTAINES GARANTIES OU LA LIMITATION DE RESPONSABILITÉ POUR CERTAINS TYPES DE DOMMAGES, CERTAINES LIMITATIONS MENTIONNÉES DANS CETTE SECTION PEUVENT NE PAS VOUS CONCERNER. RIEN DANS LES PRÉSENTES CONDITIONS D'UTILISATION NE DOIT AFFECTER TOUT DROIT ACCORDÉ PAR LA LOI QUI S'APPLIQUE À VOUS ET VOUS POURRIEZ AUSSI DISPOSER D'AUTRES DROITS QUI VARIENT D'UN TERRITOIRE À L'AUTRE.

Contrôles à l'exportation

Vous acceptez de ne pas télécharger tout Contenu ou Logiciel, ni autrement exporter ou réexporter tout Téléviseur ou Logiciel dans (ou à un ressortissant ou un résident de) Cuba, Irak, Libye, Corée du Nord, Iran, Syrie ou tout autre pays contre lequel les États-Unis ou votre pays tient un embargo, ou à toute personne figurant sur la List of Specially Designated Nationals du Treasury Department des États-Unis ou du Table of Denial Orders du Commerce Department des États-Unis ou toute autre liste restreinte similaire publiée par votre gouvernement de temps à autre. En utilisant un Téléviseur ou le Logiciel, vous représentez un pays autre que ceux figurant sur une telle liste et vous garantissez que vous n'êtes pas situé dans un tel pays, sous le contrôle d'un tel pays, ou que vous n'êtes pas un ressortissant ou un résident d'un tel pays.

Choix de compétence; règlement des litiges

- A. Si vous êtes un consommateur ou un résident d'un pays appartenant au territoire économique européen dans lequel la vente du Téléviseur est expressément autorisée par son fabricant, le présent CLUF ne s'applique pas à votre cas.
- B. Dans tous les autres cas, notamment si vous êtes un résident des États-Unis (et de ses possessions et territoires) ou du Canada, vous acceptez que cet accord de licence soit régi par les lois de l'état de la Californie, sans tenir compte de tout conflit de principes de droit qui peut s'appliquer à la loi d'un autre territoire; et :
 1. Vous et Roku acceptez d'être liés par les modalités énoncées ci-dessous pour résoudre toute réclamation entre vous et Roku résultant de tout aspect du présent CLUF ou relative à celle-ci, qu'elle se fonde sur un contrat, un délit civil, une loi, une fraude, une fausse déclaration ou toute autre théorie juridique, y compris, mais sans s'y limiter, à des réclamations entre vous et Roku liées au Téléviseur et au Logiciel. Chaque réclamation est dénommée individuellement en tant que « **Réclamation** » et collectivement en tant que « **Réclamations** ».
 2. VOUS ET ROKU CONSENTEZ À CE QUE TOUTE RÉCLAMATION ENTRE VOUS ET ROKU SOIT TRANCHÉE DE FAÇON DÉFINITIVE PAR ARBITRAGE, À L'EXCEPTION DES RÉCLAMATIONS QUI FIGURENT AU PARAGRAPHE 4 CI-APRÈS DE LA PRÉSENTE SECTION. L'arbitrage doit avoir lieu dans le comté de Santa Clara, en Californie, et doit être administré par l'American Arbitration Association (l'« AAA ») suivant les règles en vigueur de l'AAA, incluant (le cas échéant) les Procédures Additionnelles de l'AAA concernant les différends de consommateurs. Soyez informé qu'il n'y a aucun juge ni jury en arbitrage. Les procédures d'arbitrage sont simplifiées et plus limitées que les règles applicables devant les tribunaux et la révision des décisions de l'arbitre par un tribunal est limitée. VOUS ET ROKU CONSENTEZ EN OUTRE À CE QUE VOUS ET ROKU PUISSIEZ PRÉSENTER UNE RÉCLAMATION À L'ENCONTRE DE L'AUTRE PARTIE UNIQUEMENT SUR UNE BASE INDIVIDUELLE ET NON À TITRE DE REQUÉRANT OU DE MEMBRE D'UN GROUPE DANS TOUTE ACTION OU TOUT RECOURS COLLECTIF. L'ARBITRE NE PEUT CONSOLIDER OU JOINDRE PLUS D'UNE RÉCLAMATION PAR PERSONNE ET NE PEUT PRÉSIDER AUCUN RECOURS CONSOLIDÉ OU COLLECTIF. L'ARBITRE PEUT ACCORDER TOUTE FORME DE RÉPARATION (INCLUANT UNE RÉPARATION MONÉTAIRE, INJONCTION OU MESURE DÉCLARATOIRE) SUR UNE BASE INDIVIDUELLE SEULEMENT ET NE PEUT ACCORDER AUCUNE FORME DE RÉPARATION CONSOLIDÉE OU COLLECTIVE. Nonobstant toute disposition contraire, si la renonciation au recours collectif prévue au présent paragraphe est jugée invalide ou non exécutoire ou si un arbitrage est autorisé à procéder sur une base collective, ni vous ni Roku ne serez dès lors autorisés à soumettre les Réclamations à l'arbitrage. La présente clause d'arbitrage est assujettie au Federal Arbitration Act. La décision de l'arbitre liera vous et Roku et peut être homologuée par tout tribunal compétent.
 3. Vous trouverez les renseignements concernant l'AAA et la façon dont l'arbitrage est initié à l'adresse www.adr.org ou en téléphonant au 800-778-7879. Pour toute Réclamation entre Vous et Roku de 75 000 USD et moins, vous serez responsable des frais initiaux de demande d'arbitrage, jusqu'à concurrence du montant des frais initiaux de la demande que vous auriez été appelé à payer pour une poursuite judiciaire initiée pour ces mêmes Réclamations à l'encontre de Roku devant les tribunaux. Si

l'arbitre juge les Réclamations non frivoles, Roku paiera la différence entre de tels frais plus les frais de l'arbitrage. Pour toute Réclamation entre vous et Roku qui excède 75 000 USD, si vous êtes en mesure de démontrer que les frais de l'arbitrage sont prohibitifs par rapport aux frais de justice, Roku paiera le montant de vos frais de demande réels et les frais de l'arbitrage, jugés nécessaires par l'arbitre afin d'éviter que les frais d'arbitrage ne deviennent prohibitifs par rapport aux frais de justice.

4. Cette convention d'arbitrage ne concerne pas toute revendication (a) dans laquelle une partie tente de protéger ses droits de propriété intellectuelle (tels que son brevet, copyright, marque déposée, secret commercial, ou des droits moraux, mais ne comprenant pas sa vie privée ou les droits de publicité), ou (b) qui peut être intentée devant le tribunal des petites créances.
5. Si cette entente d'arbitrage est jugée invalide, non exécutoire ou inapplicable pour une Réclamation donnée entre Vous et Roku, toute procédure visant à résoudre telle Réclamation devra dès lors être présentée exclusivement devant un tribunal fédéral ayant juridiction dans le District Nord de Californie ou un tribunal d'État du comté de Santa Clara en Californie. Vous consentez irrévocablement à la juridiction exclusive de ces tribunaux.
6. **Droit de retrait de 30 jours** : vous avez le droit de vous retirer de cette entente d'arbitrage en envoyant un avis écrit de votre décision de vous retirer à l'adresse suivante : Legal Department, Roku, Inc., 12980 Saratoga Avenue, Saratoga, California 95070, États-Unis; à condition que le cachet d'un tel avis soit daté du 30e jour, ou moins, suivant le premier événement se produisant parmi les choix ci-après, si vous ne possédez pas encore de Compte Roku Account : (a) la date d'achat de Votre Téléviseur ou (b) la date de création de votre Compte Roku. Si vous possédez un compte Roku, tous les appareils que vous choisissez de lier à votre compte Roku et tous les services fournis par Roku qui sont accessibles à l'aide de ces appareils seront soumis à cette convention d'arbitrage. Votre avis doit indiquer votre prénom et nom complets, votre adresse postale, votre numéro de téléphone et votre adresse courriel actuels, le nom du produit et le numéro de série afférent à votre Téléviseur, ainsi qu'une copie de la preuve originale de l'achat de votre Téléviseur. Si vous envoyez en temps opportun un avis en conformité avec le présent paragraphe 6, la convention d'arbitrage ne pourra pas s'appliquer à vous-même ou à Roku. Si vous ne transmettez pas cet avis dans les délais impartis, alors vous consentez à être lié par cette entente d'arbitrage.
7. Nonobstant toute disposition contraire de cette Entente, vous reconnaissez que si Roku veut supprimer ou modifier substantiellement l'entente d'arbitrage ci-devant, ladite suppression ou modification ne s'appliquera pas à une Réclamation individuelle pour laquelle vous avez avisé Roku préalablement à ladite suppression ou modification.

Divers

En vertu de ce CLUF, Roku peut transférer ses droits et ses obligations à une autre organisation. Vous pouvez uniquement transférer vos droits ou vos obligations en vertu de ce CLUF à une autre personne si Roku y consent par écrit. Ce CLUF est entre vous et Roku. Aucune autre personne n'aura le droit de faire respecter ces conditions. Chacun des paragraphes du présent CLUF a effet séparément. Si un tribunal ou une autre autorité compétente décide que l'un d'entre eux est illicite, les paragraphes restants resteront en vigueur. Si Roku ne parvient pas à s'assurer que vous respectez vos obligations aux termes du présent CLUF ou si Roku n'applique pas ses droits contre vous, ou si Roku tarde à le faire, cela ne signifiera pas que Roku a renoncé à ses droits contre vous, ou que vous n'avez pas à vous conformer à ces obligations. Si Roku renonce à intenter un recours en cas de manquement de votre part, Roku ne le fera que par écrit, mais cela ne signifiera pas que Roku renoncera automatiquement à tout manquement ultérieur de vous.

Coordonnées

Si vous désirez communiquer avec Roku, veuillez nous envoyer votre courrier à l'adresse suivante :

Roku, Inc.
12980 Saratoga Avenue
Saratoga, CA 95070, États-Unis

ou par courriel à l'adresse customerservice@roku.com.

Dernière mise à jour : 20 octobre 2015

Additional TCL • Roku TV Legal Statements

FCC Statement

Note: This equipment has been tested and found to comply with the limits for a class B digital Device, pursuant to part 15 of the FCC Rules. These limits are designed to provide reasonable protection against harmful interference in a residential installation. This equipment generates, uses and can radiate radio frequency energy and, if not installed and used in accordance with the instructions, may cause harmful interference to radio Communications. However, there is no guarantee that interference will not occur in a particular installation. If this equipment does cause harmful interference to radio or television reception, which can be determined by turning the equipment off and on, the user is encouraged to try to correct the interference by one or more of the following measures:

- Reorient or relocate the receiving antenna.
- Increase the separation between the equipment and the receiver.
- Connect the equipment into an outlet on a circuit different from that to which the receiver is connected.
- Consult the dealer or an experienced radio/TV technician for help.

This Class B digital apparatus complies with Canadian ICES-003.

Declaration of Conformity

This device complies with part 15 of the FCC Rules. Operation is subject to the following two conditions: (1) This device may not cause harmful interference and (2) This device must accept any interference received, including interference that may cause undesired operation.

Please do not send any products to the California address listed in this manual or on the carton. This will only add delays in service for your product.

Macrovision statement

This product incorporates copyright protection technology that is protected by U.S. patents and other intellectual property rights. Use of this copyright protection technology must be authorized by Macrovision, and is intended for home and other limited viewing uses only unless otherwise authorized by Macrovision. Reverse engineering or disassembly is prohibited.

U.S. Patent Nos. 5,583,936; 6,836,549; 5,315,448; 6,381,747; 6,501,842; and 7,050,698.

HDMI®

The terms HDMI® and HDMI® High-Definition Multimedia Interface, and the HDMI® Logo are trademarks or registered trademarks of HDMI® Licensing LLC in the United States and other countries.



Dolby Digital

Manufactured under license from Dolby Laboratories.

“Dolby” and the double-D symbol are registered trademarks of Dolby Laboratories.



Roku

Roku and the Roku logo are registered trademarks of Roku, Inc. in the United States and other countries.

